

Pioneer Dj

DJ Controller

DDJ-SX3

serato ||  **serato** DJ Pro

pioneerdj.com/support/

<http://serato.com/>

For FAQs and other support information for this product, visit the above site.

Operating Instructions

Contents

How to read this manual

Thank you for buying this Pioneer DJ product.

- Be sure to read both this guide and the "Operating Instructions (Quick Start Guide)". Both documents include important information that you must understand before using this product.
- Please note that the screens and specifications of the software described in this guide as well as the external appearance and specifications of the hardware are currently under development and may differ from the final specifications.
- Please note that depending on the operating system version, web browser settings, etc., operation may differ from the procedures described in this guide.
- Please note that the language on the screens of the software describes in this guide may differ from the language on your screens.

This manual consists mainly of explanations of functions of this unit as hardware. For detailed instructions on operating Serato DJ Pro, refer to the Serato DJ Pro Manual.

- The software manual for Serato DJ Pro can be downloaded from "Serato.com". For details, see "Downloading the Serato DJ Pro software manual" (p.3).
- The latest "Operating Instructions" (this guide) can be downloaded from the Pioneer DJ support site. For details, see "Viewing the Operating Instructions" (p.3).

05 Changing the settings.....	31
About the setting utility	31
Changing the settings.....	31
Launching the utilities mode.....	32
Utilities modes	32
Adjusting the sensitivity of the jog wheel touch sensor.....	35

06 Additional information.....	36
Troubleshooting	36
Audio Block Diagram	38
Using as a controller for other DJ software.....	38
About trademarks and registered trademarks	40
Cautions on copyrights	40

01 Before start.....	3
Features	3
What's in the box	3
Acquiring the manual	3
Installing the software.....	3

02 Part names and functions.....	6
Browser section	6
Deck sections.....	7
Mixer section	9
Effect section.....	10
Rear panel	11
Front panel	12
Jog wheel display section	13

03 Basic operation.....	14
Connecting devices to this unit.....	14
Playing music by operating Serato DJ Pro.....	15
Quitting the system	17
Connection example.....	18

04 Advanced operation	20
Using the performance pads.....	20
Using the pitch play.....	22
Using the Serato Flip	22
Using the Saved Flip.....	23
Using the slip	24
Using DUAL DECK mode	25
Using the fader start function.....	25
Using the velocity sampler.....	26
Analyzing tracks.....	26
Using effects	26
Using SOUND COLOR FX.....	28
Effect types	28
Using external inputs / microphone	29

Before start

Features

This unit is an all-in-one DJ controller designed specifically for Serato Limited's professional DJ software "Serato DJ Pro." Performance interfaces, such as "PERFORMANCE PADS," "4-CHANNEL MIXER," etc., are arranged comfortably to control functions included in "Serato DJ Pro."

In addition, this unit is equipped with abundant input/output terminals to correspond to various DJ performances. This unit is also designed with a sense of quality to correspond to various scenes such as clubs and home parties.

What's in the box

- AC adapter
 - Power plug
 - USB cable^[1]
 - Warranty card (for some regions)^[2]
 - Operating Instructions (Quick Start Guide)
 - Serato DJ Pro EXPANSION PACK VOUCHER^[3]
- [1] Only one USB cable is supplied on this unit. If you use two cables, use a USB cable supported to USB2.0.
- [2] Only for the product in the European region.
- For the North American region, the corresponding information is provided on the last page of both the English and French versions of the "Operating Instructions (Quick Start Guide)."
 - For the Japanese region, the corresponding information is provided on the back cover of the "Operating Instructions (Quick Start Guide)."
- [3] Note that the Serato DJ Pro EXPANSION PACK VOUCHER cannot be reissued. You will need to use the voucher code to activate the expansion pack. Make sure to store it in a safe place so that you do not lose it.

Acquiring the manual

Various instructions are sometimes provided as files in PDF format. Adobe® Reader® must be installed in order to view PDF format files.

Viewing the Operating Instructions

1 Launch a web browser on the PC/Mac and access the Pioneer DJ site below.

pioneerdj.com

- To select your language, click the flag icon on the upper-right screen.

2 Point the cursor to [Support].

3 Click [Tutorials, manuals & documentation].

4 Click [DDJ-SX3] under [DJ CONTROLLER].

5 Select the language of the manual from the list.

Download the manual if needed.

Downloading the Serato DJ Pro software manual

1 Access the Serato site.

http://serato.com/

2 Click [Serato DJ Pro] from [PRODUCTS].

3 Click [DOWNLOAD SERATO DJ PRO].

4 Click [Manuals and Downloads].

5 Click the Serato DJ Pro software manual of the required language.

Installing the software

Before installing the software

The Serato DJ Pro software and driver software are not included. Access and download the software from the Pioneer DJ support site. pioneerdj.com/support/

- The user is responsible for preparing the PC/Mac, network devices and other elements of the Internet usage environment required for a connection to the Internet.

Downloading the driver software

1 Launch a web browser on the PC/Mac and access the Pioneer DJ site.

pioneerdj.com

- To select your language, click the flag icon on the upper-right screen.

2 Point the cursor to [Support].

3 Click [Software & firmware updates].

4 Click [DDJ-SX3] under [DJ CONTROLLER].

5 Click [Drivers].

6 Click [Download link], and then save the file.

About the Serato DJ Pro software

Serato DJ Pro is a professional DJ software application by Serato Limited. DJ performances are possible by connecting the PC/Mac on which this software is installed to this unit.

Minimum operating environment

Supported operating systems	CPU and required memory
Mac: macOS High Sierra 10.13/Sierra 10.12, OS X 10.11 (latest update)	Intel® processor Core™ i3, i5 and i7 1.07 GHz or better 4 GB or more of RAM
Windows® 10 / Windows® 8.1 / Windows® 7 (latest service pack)	32-bit version: Intel® processor Core™ i3, i5 and i7 1.07 GHz or better 4 GB or more of RAM 64-bit version: Intel® processor Core™ i3, i5 and i7 1.07 GHz or better 4 GB or more of RAM

Others

USB port	A USB 2.0 port is required to connect the PC/Mac with this unit.
Display resolution	Resolution of 1 280 × 720 or greater

Internet connection An Internet connection is required for registering the "Serato.com" user account and downloading the software.

- For information on the latest system requirements, compatibility, and supported operating systems, see "Software Info" of "DDJ-SX3" on the Pioneer DJ support site below.
pioneerdj.com/support/
- As for operating systems, use the latest version and latest service pack.
- Operation is not guaranteed on all PC/Mac, even if all the required operating environment conditions indicated here are fulfilled.
- Depending on the power saving settings, etc. of the PC/Mac, the CPU and hard disk may not provide sufficient processing capabilities. For laptop PCs and Mac books in particular, make sure the computer is in the proper conditions to provide constant high performance (for example by keeping the AC power connected) when using Serato DJ Pro.
- Use of the Internet requires a separate contract with a provider offering Internet services and payment of provider fees.

❖ Obtaining the Serato DJ Pro software

1 Access the Serato web site.

<http://serato.com/>

2 Click [Serato DJ Pro] under [DJ PRODUCTS].

The Serato DJ Pro download page is displayed.

- The download page is subject to change.

3 Click [DOWNLOAD SERATO DJ PRO].

4 Create an account of "Serato.com".

- If you have already registered a user account on "Serato.com", proceed to step 6.
- If you have not completed registering your user account, do so following the procedure below.
 - Following the instructions on the screen, input your email address and the password to set, and then select the region in which you live.
 - If you check [E-mail me Serato newsletters], newsletters providing the latest information on Serato Limited products will be sent from Serato Limited.
 - Once user account registration is completed, you will receive an e-mail at the e-mail address you have input. Check the contents of the email sent from "Serato.com."
- Be careful not to forget the email address and password specified when you performed user registration. They will be required for updating the software.
- The personal information input when registering a new user account may be collected, processed and used based on the privacy policy on the Serato Limited website.

5 Click the link in the e-mail message sent from "Serato.com."

This takes you to the Serato DJ Pro download page.

6 Log in.

Input the email address and password you have registered to log in to "Serato.com."

7 Download the Serato DJ Pro software from the download page.

❖ Installation procedure (Windows)

Do not connect this unit and the PC until installation is completed.

- Log on as the user which was set as the administrator of the PC before installing.
- If any other programs are running on the PC, quit them.

1 Unzip the downloaded driver software (DDJSX3XXXX.zip).

2 Double-click [DDJ-SX3_X.XXX.exe].

3 Proceed with installation according to the instructions on the screen.

If [Windows Security] appears on the screen while the installation is in progress, click [Install this driver software anyway] and continue with the installation.

When the installation program is completed, a completion message appears.

After installing the driver software, install the Serato DJ Pro software.

4 Unzip the downloaded Serato DJ Pro software file.

5 Double-click the unzipped software file to launch the installer.

6 Read the terms of the license agreement carefully, and if you agree, select [I agree to the license terms and conditions], then click [Install].

- If you do not agree to the contents of the license agreement, click [Close] to cancel installation.

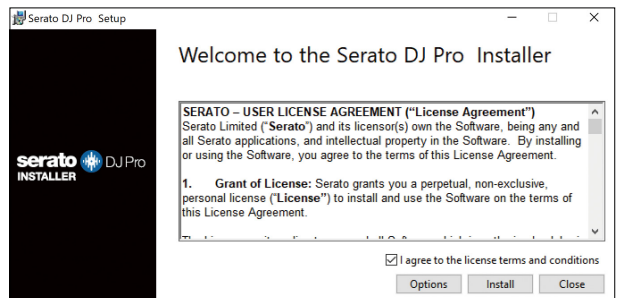

The message of successful installation appears when installation is completed.

7 Click [Close] to quit the Serato DJ Pro installer.

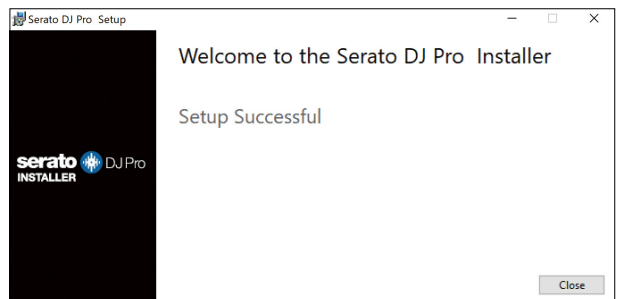

❖ Installation procedure (Mac)

Do not connect this unit and the Mac until installation is completed.

- If any other programs are running on the Mac, quit them.

1 Unzip the downloaded driver software (DDJSX3MXXX.zip).

2 Double-click [DDJ-SX3_M_X.X.X.dmg].

3 Double-click [DDJ-SX3_AudioDriver.pkg].

4 Follow the displayed instructions to install.

5 Unzip the downloaded Serato DJ Pro software file.

6 Double-click the unzipped software file to launch the installer.

7 Read the terms of the license agreement carefully, and if you agree, click [Agree].

To continue installing the software you must agree to the terms of the software license agreement.

Click Agree to continue or click Disagree to cancel the installation and quit the Installer.

Read License

Disagree

Agree

- If you do not agree to the contents of the usage agreement, click [Disagree] to cancel installation.

8 Click [Install].

9 Follow the displayed instructions to install.

10 Click [Close] to quit the installer.

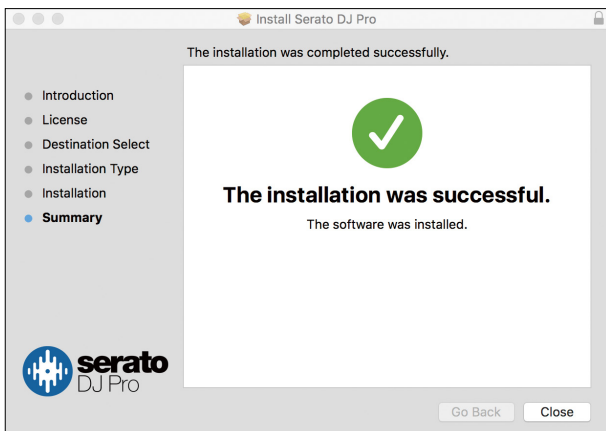

About installing the driver software into macOS High Sierra 10.13

For macOS High Sierra 10.13, the new security function is added. When installing Pioneer DJ driver software into macOS High Sierra 10.13, the driver software authentication is required. Follow the procedures below.

Following procedures are necessary when newly installing the driver software into macOS High Sierra 10.13.

If the driver software has been installed into macOS or OS X before updating to macOS High Sierra 10.13, following procedures are not necessary.

When installing Pioneer DJ driver software into macOS High Sierra 10.13, the following screen is displayed.

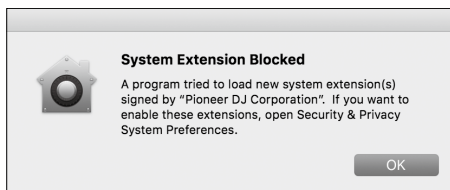

Click [OK].

After permitting the driver software installation, the driver software installing will be completed.

1 Open [System Preferences], and then click [Security & Privacy].

2 Check that [System software from developer "Pioneer DJ Corporation" was blocked from loading.] is displayed on the lower screen.

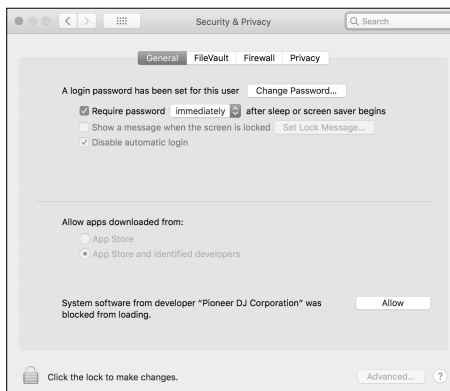

This is shown for 30 minutes from starting the driver software installation.

If it is not shown, repeat the procedure of the driver software installation.

3 Click [Allow] on the lower-right screen.

4 If the DJ equipment is connected to Mac, disconnect the USB cable, and then connect it again.

Part names and functions

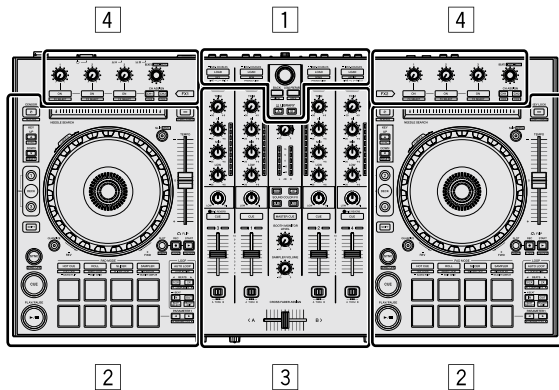

- 1 Browser section
- 2 Deck sections
- 3 Mixer section
- 4 Effect sections

Browser section

1 to 4 buttons and selector operate PC/Mac selected by 5 LIBRARY A button or 6 LIBRARY B button.

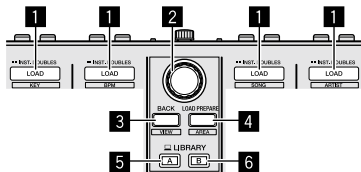

1 LOAD button

Press:

The selected tracks are loaded to the respective decks.

- If you press the [LOAD] button twice on the side opposite to the deck currently playing, the state of the deck currently playing is also applied to the deck on the opposite side. (Instant double)

[SHIFT] + press:

When pressing each [LOAD] button, the track list in the library is sorted.

- : Sorts by key.
- : Sorts by BPM.
- : Sorts by track names in alphabetical order.
- : Sorts by artist names.

2 Rotary selector

Turn:

The cursor in the library panel or [crates] panel moves up or down.

Press:

When the cursor is in the [crates] panel or library panel, the cursor moves between the [crates] panel and library panel each time the rotary selector is pressed.

When the cursor is in the [Files] panel, the cursor moves to a lower layer.

When the cursor is in the [Browse] panel, the cursor moves to the previous category.

- For details on the crates panel, see "Importing tracks" (p.16).

3 BACK button

Press:

When the cursor is in the [crates] panel or library panel, the cursor moves between the crates panel and library each time the button is pressed.

If there are sub crates for the item currently selected in the crates panel, those crates are expanded or collapsed.

When the cursor is in the [Files] panel, the cursor moves to a higher layer.

When the cursor is in the [Browse] panel, the cursor moves to the previous category.

[SHIFT] + press:

The layout of Serato DJ Pro is changed.

4 LOAD PREPARE button

Press:

A track is loaded into the [Prepare] panel.

[SHIFT] + press:

The panel display switches each time the button is pressed.

Panel display off → Files → Browse → PREPARE → History →

Panel display off.

5 LIBRARY A button

Press:

Select PC/Mac connected to [USB A].

6 LIBRARY B button

Press:

Select PC/Mac connected to [USB B].

Deck sections

This section is used to control the four decks. Controls and buttons to operate decks 1 and 3 are located on the left side of the controller, and those to operate decks 2 and 4 are located on the right side of the controller.

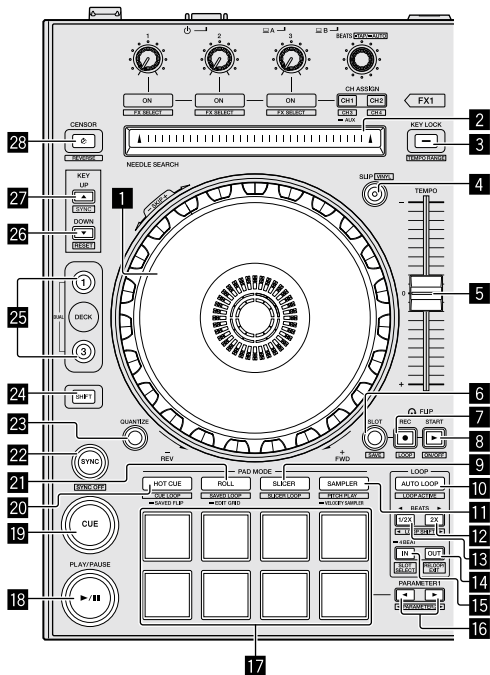

1 Jog wheel

Turn top:

When the vinyl mode is on, the scratch operation is possible.
When the vinyl mode is off, the pitch bend operation (adjustment of the playing speed) is possible.

Turn outer section:

The pitch bend operation (adjustment of the playing speed) is possible.

[SHIFT] + turn top:

The playback position skips in sync with the beat. (Skip mode)

- The skip mode cannot be used with tracks for which no beatgrid is set. For details on setting beatgrids, see the Serato DJ Pro software manual.
- To use the skip mode, set [SYNC PREFERENCES] to [Smart Sync] in the [SETUP] menu of Serato DJ Pro.

2 NEEDLE SEARCH pad

By touching the pad, you can jump to the desired position in the track loaded in the deck.

3 KEY LOCK button

Press:

Turns the key lock function on and off.

When the key lock function is on, the key does not change even when the playing speed is changed with the [TEMPO] slider.

- The sound is digitally processed, so the sound quality decreases.

[SHIFT] + press:

The [TEMPO] slider's range of variation switches each time the button is pressed.

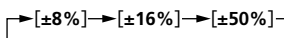

Press for 1 second or longer:

Sets the tempo (BPM) of the currently playing track back to its original tempo.

4 SLIP button

Turns on/off the slip mode.

- ➔ "Using the slip" (p.24)

[SHIFT] + press:

Turns on/off the vinyl mode.

5 TEMPO slider

Use this to adjust the track playing speed.

6 FLIP SLOT button

7 FLIP REC button

8 FLIP START button

Allows you to record or call sequences such as HOT CUE operation. This function (Serato Flip) needs to be activated before it can be used.

For details, visit the Pioneer DJ support site below.
pioneerdj.com/support/

9 SLICER mode button

Press:

Sets the slicer mode.

[SHIFT] + press:

Sets the slicer loop mode.

- To cancel the slicer mode and slicer loop mood, press any of the [ROLL] mode, [SAMPLER] mode or [HOT CUE] mode button.

10 AUTO LOOP button

Press:

Turns on/off the auto loop.

- Cancels the loop during loop playback.

[SHIFT] + press:

Switches looping between active and non-active. (Loop Active)

- Even if looping is active, loop playback is not performed without the playback position in that loop.
- When the playback position enters the active loop, loop playback starts.
- During loop playback, this operation cancels looping.

11 SAMPLER mode button

Press:

Sets the sampler mode.

[SHIFT] + press:

Sets the pitch play mode.

- ➔ "Using the pitch play" (p.22)

Press for 1 second or longer:

Sets velocity sampler mode.

- ➔ "Using the velocity sampler" (p.26)

12 LOOP 2X button

Press:

Selects the auto loop beat.

Doubles the loop playback length.

[SHIFT] + press:

During loop playback, moves the loop to the right by the amount equal to its length. (Loop Shift)

13 LOOP 1/2X button

Press:

Selects the auto loop beat.

Halves the loop playback length.

[SHIFT] + press:

During loop playback, moves the loop to the left by the amount equal to its length. (Loop Shift)

14 LOOP OUT button

Press:

Loop Out Point is set, and loop playback begins.

When this button is pressed during loop playback, the loop out point can be fine adjusted using the jog wheel.

[SHIFT] + press:

Cancels loop playback. (Loop Exit)

After loop playback is canceled, playback returns to the previously set loop in point and loop playback resumes. (Reloop)

15 LOOP IN button

Press:

Loop In Point is set.

When this button is pressed during loop playback, the loop in point can be fine adjusted using the jog wheel.

[SHIFT] + press:

The loop slot switches.

When loops are stored in loop slots ahead of time, they can be called out later.

- Up to 8 loops can be set in the loop slots.
- When you select the loop slot number at which you want to store the loop then set a loop, the loop is automatically stored.
- When a new loop is set after a loop has been stored, the loop is overwritten and the slot is updated.
- When the number of the loop slot whose loop you want to call out is selected and the [LOOP OUT] button is pressed while pressing the [SHIFT] button (reloop), playback of the stored loop starts.

Press for 1 second or longer:

Turns the auto 4-beat loop on.

16 PARAMETER ◀ button, PARAMETER ▶ button

Sets a parameter for the loop roll, slicer, sampler and other functions.

☞ "Using the performance pads" (p.20)

17 Performance pads

Control the hot cue, loop roll, slicer, sampler and other functions.

☞ "Using the performance pads" (p.20)

18 PLAY/PAUSE ▶/II button

Press:

Play/pause tracks.

[SHIFT] + press:

Returns to the temporary cue point and playback starts. (Stutter)

19 CUE button

Press:

This is used to set, play and call out temporary cue points.

- When the [CUE] button is pressed while pausing, the temporary cue point is set.
- When the [CUE] button is pressed during playback, the track returns to the temporary cue point and pauses. (Back Cue)
- When the [CUE] button is pressed and held after the track returns to the temporary cue point, playback continues as long as the button is pressed in. (Cue Sampler)
- When the [PLAY/PAUSE ▶/II] button is pressed during cue sampling, playback continues from that point.

[SHIFT] + press:

Loads the previous track in the library panel. (Previous Track)

- If the current playback position is not at the beginning of a track, the track returns to the beginning.

20 HOT CUE mode button

Press:

Sets the hot cue mode.

[SHIFT] + press:

Sets the cue loop mode.

Press for 1 second or longer:

Sets the saved flip mode.

For details, refer to "Serato Flip manual" under [Software Info] on the following Pioneer DJ support site.
pioneerdj.com/support/

21 ROLL mode button

Press:

Sets the roll mode.

[SHIFT] + press:

Sets the saved loop mode.

Press for 1 second or longer:

Sets the edit grid mode.

☞ "Using the edit grid" (p.23)

22 SYNC button

Press:

The tempos (pitches) and beat grids of tracks on multiple decks can be synchronized automatically.

[SHIFT] + press:

Cancels the sync mode.

23 QUANTIZE button

Turns on/off the quantize.

24 SHIFT button

When another button is pressed while pressing the [SHIFT] button, a different function is called out.

25 DECK button

Press:

Switches the deck to be operated.

Pressing the [DECK3] button while holding down the [DECK1] button or pressing the [DECK1] button while holding down the [DECK3] button:

Turns on DUAL DECK mode on the left deck.

Pressing the [DECK4] button while holding down the [DECK2] button or pressing the [DECK2] button while holding down the [DECK4] button:

Turns on DUAL DECK mode on the right deck.

26 KEY DOWN/RESET button

Press:

Turns down the key.

[SHIFT] + press:

When pressing during KEY SYNC, the key is resumed.

25 and 26 buttons are supported to the Pitch'n Time function. To use this function, the activation is required. For details, refer to "Serato Pitch'n Time manual" under [Software Info] on the following Pioneer DJ support site.
pioneerdj.com/support/

27 KEY UP/SYNC button

Press:

Turns up the key.

[SHIFT] + press:

Changes the key to same as another deck.

28 CENSOR button

Press:

The track is played in the reverse direction while the **[CENSOR]** button is pressed, and normal playback resumes when the button is released.

- Even during playback in the reverse direction, normal playback continues in the background. When the button is released, playback resumes from the point reached in the background.

[SHIFT] + press:

The track is played in the reverse direction. When the **[SHIFT]** and **[CENSOR]** buttons are pressed again, reverse playback is canceled and normal playback resumes.

Mixer section

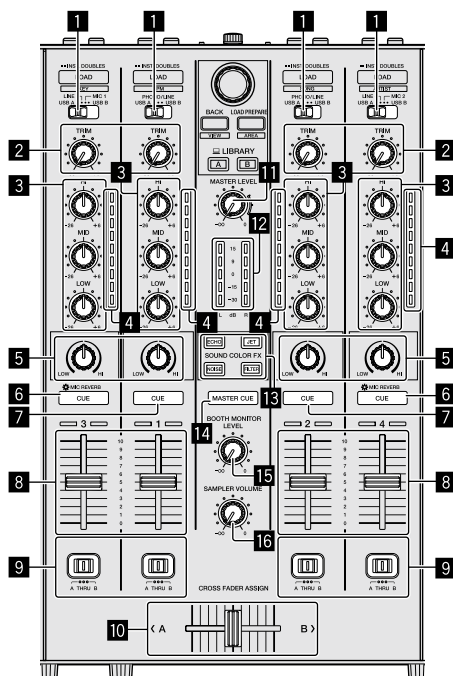

1 Input select switch

Selects the input source of each channel from the components connected to this unit.

- **[USB A]** or **[USB B]**: Select to use the track loaded in the Serato DJ Pro software's deck.
- **[MIC1]** or **[MIC2]**: Select one of these to use the microphone connected to the **[MIC1]** or **[MIC2]** terminal.
- **[PHONO/LINE]**: Selected when using an phono level (for MM cartridge) output device such as an analog turntable connected to the **[PHONO/LINE]** input terminals.
- The sound is muted for approximately 3 seconds when switched to **[PHONO]**.
- **[LINE]**: Select this to use a line level output device (DJ player, etc.) connected to the **[PHONO/LINE]** input terminals.

2 TRIM control

Adjusts the individual channel output gain.

3 EQ (HI, MID, LOW) controls

Boost or cut frequencies for the different channels.

4 Channel Level indicator

Displays the sound level of the respective channels before passing through the channel faders.

5 COLOR controls

Change the parameter of SOUND COLOR FX for each channel.

6 Headphones CUE/MIC REVERB button

Press:

The sound of channels for which the headphones [CUE] button is pressed is output to the headphones.

- When the headphones [CUE] button is pressed again, monitoring is canceled.

When the input select switch for channel 3 or 4 is set to [MIC1] or [MIC2], the reverb function can be turned on/off. When the reverb function is on, the effect can be adjusted on the setting utilities.

☞ "About the setting utility" (p.31)

[SHIFT] + press:

The track's tempo can be set by tapping the button. (Tap function)

- When the tap function is used, the deck section's display on the PC/Mac screen switches to the [Beatgrid Editor] display. To switch the deck section's display back to how it was before, click [Edit Grid] on the PC/Mac screen.

7 Headphones CUE buttons

Press:

The sound of channels for which the headphones [CUE] button is pressed is output to the headphones.

- When the headphones [CUE] button is pressed again, monitoring is canceled.

[SHIFT] + press:

The track's tempo can be set by tapping the button. (Tap function)

- When the tap function is used, the deck section's display on the PC/Mac screen switches to the [Beatgrid Editor] display. To switch the deck section's display back to how it was before, click [Edit Grid] on the PC/Mac screen.

8 Channel fader

Move:

Adjusts the level of audio signals output in each channel.

[SHIFT] + move:

Uses the fader start function.

☞ "Using the channel fader start function" (p.25)

9 CROSS FADER ASSIGN switch

Assigns the channel output to the crossfader.

[A]: Assigns to [A] (left) of the crossfader.

[B]: Assigns to [B] (right) of the crossfader.

[THRU]: Selects this when you do not want to use the crossfader. (The signals do not pass through the crossfader.)

- If microphone sound is selected using the input select switch of channel 3 or channel 4, even through the [CROSS FADER ASSIGN] switch is switched, the sound of that channel cannot be assigned to the crossfader.

10 Crossfader

Outputs the sound assigned with the [CROSS FADER ASSIGN] switch.

[SHIFT] + move:

Uses the crossfader start function.

☞ "Using the crossfader start function" (p.25)

11 MASTER LEVEL control

Adjusts the master sound level output.

12 Master level indicator

Displays the master output's audio level.

13 SOUND COLOR FX button

Turns on/off SOUND COLOR FX.

14 MASTER CUE button

Turns on to output the master sound from the headphones.

15 BOOTH MONITOR LEVEL control

Adjusts the level of audio signals output from the [BOOTH OUT] terminal.

16 SAMPLER VOLUME control

Adjusts the sampler's overall sound level.

Effect section

This section is used to control the two effect units (FX1 and FX2).

Controls and buttons to operate the FX1 unit are located on the left side of the controller, those to operate the FX2 unit are located on the right side of the controller. The channels to which the effect is to be applied are set using the [CH ASSIGN] buttons on the mixer.

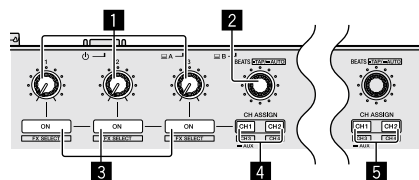

1 Effect parameter controls

Adjust the effects' parameters.

2 FX BEATS control

Turn:

Adjusts the effect time.

[SHIFT] + press:

☞ "Switching the effect's tempo mode" (p.28)

3 Effect parameter buttons

Press:

Turn on/off the effect or switch the parameter.

[SHIFT] + press:

Switch the effect type.

4 FX1 CH ASSIGN buttons

Turn on/off the effect unit FX1 for each channel.

5 FX2 CH ASSIGN buttons

Turn on/off the effect unit FX2 for each channel.

Rear panel

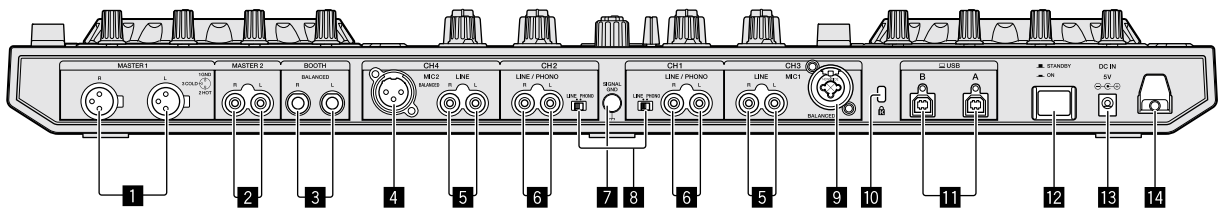

1 MASTER OUT 1 terminals

Connect powered speakers, etc., here.

- Compatible with XLR connector type balanced outputs.
- **Do not connect any terminal which provides phantom power to these terminals or a power cord of another product.**

2 MASTER OUT 2 terminals

Connect to a power amplifier, etc.

- Compatible with RCA pin-jack type unbalanced outputs.

3 BOOTH OUT terminals

Output terminals for a booth monitor, compatible with balanced or unbalanced output for a TRS connector.

The master channel sound can be output from the [BOOTH OUT] terminals regardless of the audio level set for the master channel.

- The sound will be distorted if the level is raised too high when using unbalanced outputs.
- The default setting of booth monitor output has been set to output the microphone sound. In the utilities mode, it is possible to set not to output the microphone sound.
 - ➔ "About the setting utility" (p.31)

4 MIC2 terminal

Connects a microphone here.

- The input select switch on the mixer section must be set to [MIC2].

5 LINE terminals

Connect to a DJ player or other line level device.

- The input select switch on the mixer section must be set to [LINE].

6 LINE/PHONO input terminals

Connect to a phono level (for MM cartridge) output device such as an analog turntable or line level output device such as a DJ player. Depending on the device connected, the terminal function can be switched using the [LINE/PHONO] switch at next to the terminal.

7 SIGNAL GND terminal

Connect an analog turntable ground wire here. This helps reduce noise when the analog turntable is connected.

8 LINE/PHONO switches

9 MIC1 terminal

Connects a microphone here.

- The input select switch on the mixer section must be set to [MIC1].
- Either an XLR connector or a phones plug (Ø 6.3 mm) can be used.

10 Kensington security slot

Connects a wired lock for theft prevention.

11 USB terminals

Connects to a PC/Mac.

- Connect this unit and the PC/Mac directly using the included USB cable.
- A USB hub cannot be used.

12 STANDBY/ON switch

This switches this unit's power between on and standby.

13 DC IN terminal

Connect to a power outlet using the included AC adapter (with the power plug mounted).

- Connect the AC adapter after all the connections between devices have been completed.
- Only use the included AC adapter.

14 Cord hook

Catch the AC adapter's power cord on this hook when using this unit.

- The sound will be interrupted if the AC adapter is disconnected during playback.

Front panel

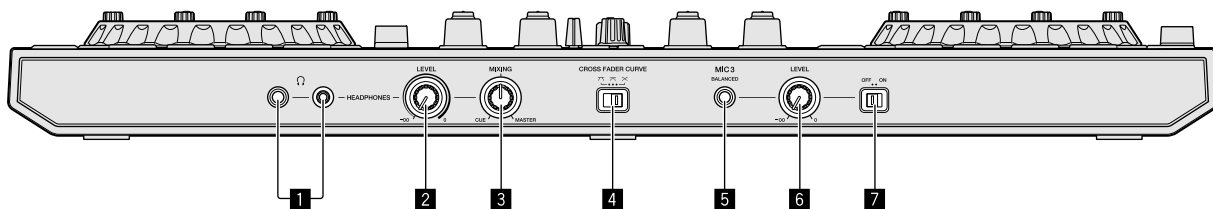

1 HEADPHONES jacks

Connect headphones here.

Both stereo phone plugs (Ø 6.3 mm) and stereo mini phone plugs (Ø 3.5 mm) can be used.

- There are two input jacks, both a stereo phones jack and a mini phones jack, but do not use both simultaneously. If both are used simultaneously, when one is disconnected and/or connected, the volume of the other may increase or decrease suddenly.

2 HEADPHONES LEVEL control

Adjusts the audio level output from the [HEADPHONES] jack.

3 HEADPHONES MIXING control

Adjusts the monitoring balance of sound between the channel with headphones [CUE] button pressed and master channel.

4 CROSS FADER CURVE switch

- [A]: Switch to a steeply rising curve. (As soon as the crossfader leaves from [A] end, the sound on the [B] side is output.)
- [B]: Switch to an intermediate curve between the top and bottom.
- [X]: Switch to a gradually rising curve. (As the crossfader leaves from [A] end, the sound on the side [B] gradually increases and the sound on the side [A] gradually decreases.)

5 MIC3 terminal

Connects a microphone here.

6 MIC3 LEVEL control

Adjusts the sound level for the [MIC3] channel.

7 MIC3 ON/OFF switch

Turns on/off [MIC3].

Jog wheel display section

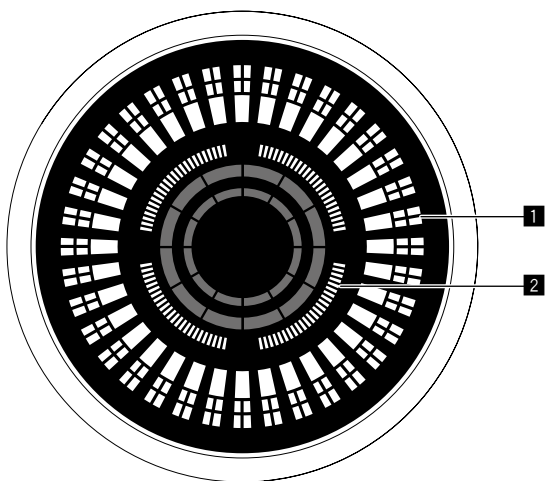

1 Operation display

Operates synchronously with the Serato DJ Pro platter position indicator. One rotation equals one rotation of the platter.

For display, separate patterns can be stored for decks 1 or 2, and decks 3 or 4, respectively, and one of five patterns can be selected.

- "Changing illumination mode in the white area of the jog wheel" (p.34)
- During sensitivity adjustment of the touch sensor of the jog dial, the set sensitivity is indicated.

2 Hot cue point display/slip play display

When the playback position is on a hot cue point, all indicators light. The number of indicators lighted changes depending on the distance from the hot cue point to the playback position.

- As with the **[SLIP]** button, it is possible to display the slip status.
- "Switching the illumination mode in the red area of the jog wheel" (p.34)

Basic operation

- Connect the AC adapter after all connections are completed. Before connecting to the device or changing the connection, turn off the power and unplug the AC adapter from the outlet.
- Only use the AC adapter included with this unit.
- Power is supplied by the AC adapter.
- Connect the unit and PC/Mac directly using the included USB cable.
- A USB hub cannot be used.
- Please also refer to the instruction manual of the device to be connected.

Connecting devices to this unit

1 Connect headphones to one of the [HEADPHONES] jacks.

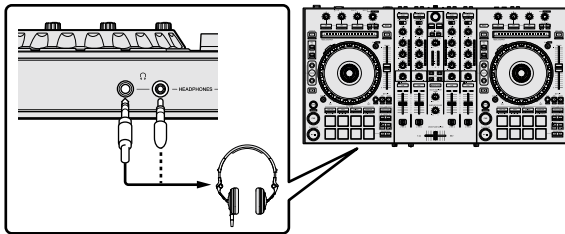

2 Connect powered speakers, a power amplifier, components, etc., to the [MASTER OUT 1] or [MASTER OUT 2] terminals.

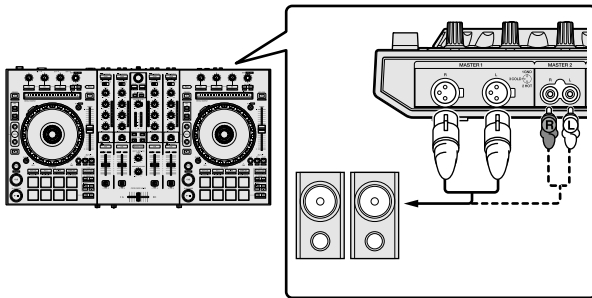

- To output the sound from the [BOOTH OUT] terminals, connect speakers or other devices to the [BOOTH OUT] terminals.
- For details on connecting the input/output terminals, see "Connection example" (p.18).

3 Connect this unit to your PC/Mac via a USB cable.

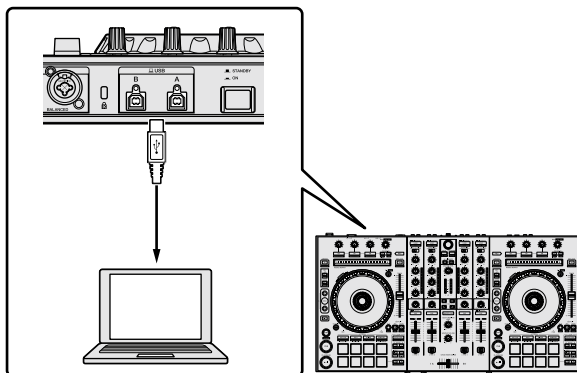

4 Turn on the PC/Mac.

5 Connect the power plug to the AC adapter.

Slide the power plug into the AC adapter's guide rails as shown on the diagram and press in until a click is heard.

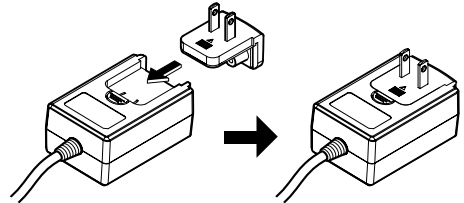

- For detailed cautions on the AC adapter, refer to "Operating Instructions (Quick Start Guide)".
- The shape of the plug differs according to the region in which the unit is sold.

6 Connect the AC adapter.

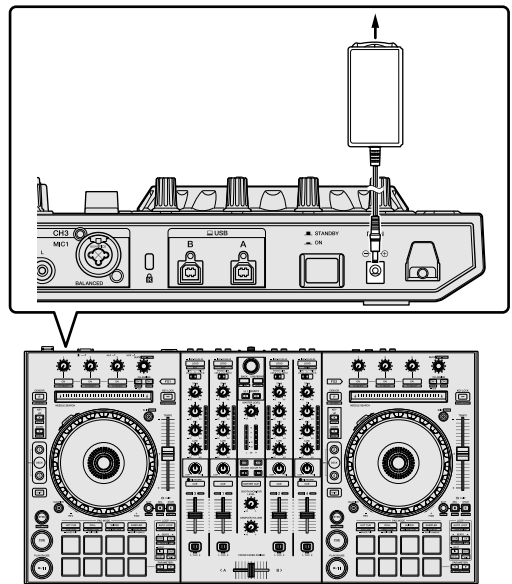

7 Press the [STANDBY/ON] switch on the rear panel to turn on this unit.

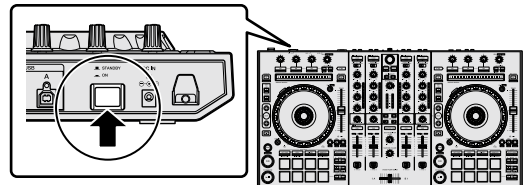

- For Windows users
The message [Installing device driver software] may appear when this unit is first connected to the PC or when it is connected to a different USB port on the PC. Wait a while until the message [Your devices are ready for use] appears.

8 Turn on the devices connected to the output terminals (powered speakers, power amplifier, components, etc.).

- When a microphone, DJ player or other external device is connected to input terminals, the power of that device also turns on.

Playing music by operating Serato DJ Pro

Launching Serato DJ Pro

This manual consists mainly of explanations of functions of this unit as hardware. For detailed instructions on operating the Serato DJ Pro software, see the Serato DJ Pro software manual.

For Mac

In Finder, open the [Applications] folder, then click the [Serato DJ Pro] icon.

For Windows 10

From the [Start] menu, click [Serato] > [Serato DJ Pro] icon.

For Windows 8.1

From [Apps view], click the [Serato DJ Pro] icon.

For Windows 7

From the Windows [Start] menu, click the [Serato DJ Pro] icon under [All Programs] > [Serato].

PC/Mac screen directly after the Serato DJ Pro software is launched

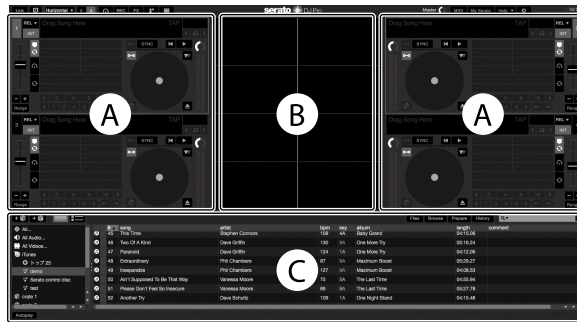

- The [BUY/ACTIVATE] icon may appear on the right side of the screen displayed when Serato DJ Pro is launched for the first time, but for those using DDJ-SX3 there is no need to activate or purchase a license.

PC/Mac screen when a track is loaded in the Serato DJ Pro software

Click [Library] at the upper left of the PC/Mac screen, then select [Vertical] or [Horizontal] from the pull-down menu to switch the Serato DJ Pro screen.

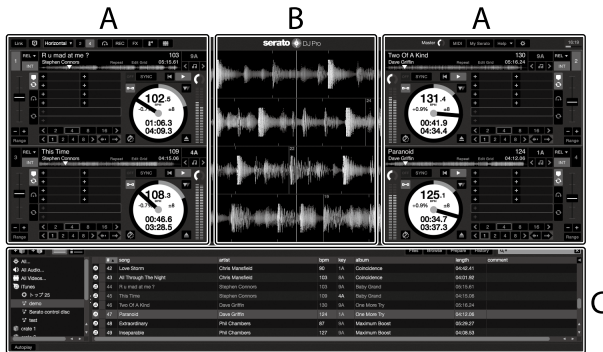

A Deck section

The track information (the name of the loaded track, artist name, BPM, etc.), the overall waveform and other information is displayed here.

B Waveform display

The loaded track's waveform is displayed here.

C Browser section

Crates in which tracks in the library or sets of multiple tracks are stored are displayed here.

Importing tracks

The following describes the typical procedure for importing tracks.

- There are various ways to import tracks with the Serato DJ Pro software. For details, see the Serato DJ Pro software manual.
- If you are already using Serato Limited's DJ software (Scratch Live, ITCH, Serato DJ Intro, or Serato DJ Lite) and have already created track libraries, the track libraries you have previously created can be used as such.
- If you are using Serato DJ Intro and have already created track libraries, you may have to reanalyze the tracks.

1 Click the [Files] key on the Serato DJ Pro screen to open the [Files] panel.

The contents of your PC/Mac or the peripheral connected to the PC/Mac are displayed in the [Files] panel.

2 Click the folder on the [Files] panel containing the tracks you want to add to the library to select it.

3 On the Serato DJ Pro screen, drag and drop the selected folder to the crates panel.

A crate is created and the tracks are added to the library.



b

a [Files] panel

b crates panel

2 Press this unit's [BACK] button, move the cursor to the crates panel on the PC/Mac screen, then turn the rotary selector to select the crate, etc.

3 Press the rotary selector, move the cursor to the library on the PC/Mac screen, then turn the rotary selector and select the track.

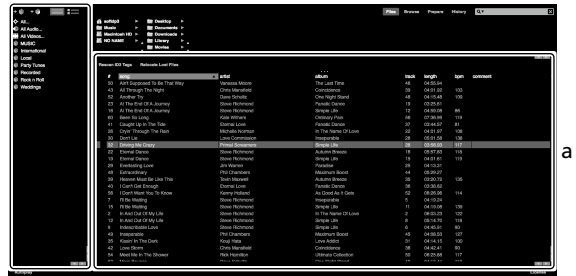

b

a Library

b crates panel

4 Press the [LOAD] button to load the selected track onto the deck.

Playing tracks and outputting the sound

The following describes the procedure for outputting the channel 1 sound as an example.

- Set the volume of the devices (power amplifier, powered speakers, etc.) connected to the [MASTER OUT 1] and [MASTER OUT 2] terminals to an appropriate level. Note that loud sound will be output if the volume is set too high.

Loading tracks and playing them

The following describes the procedure for loading tracks into deck [1] as an example.

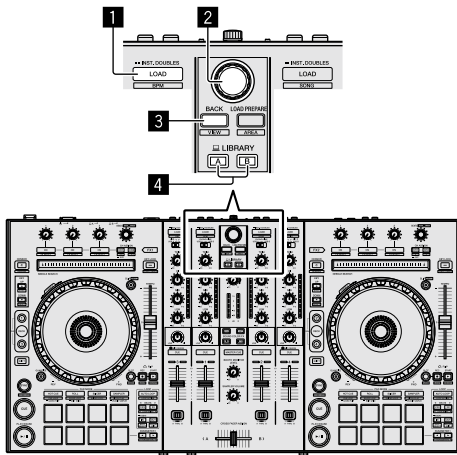

1 LOAD button

2 Rotary selector

3 BACK button

4 LIBRARY A button

LIBRARY B button

1 Press the [LIBRARY A] button or the [LIBRARY B] button and select the PC/Mac.

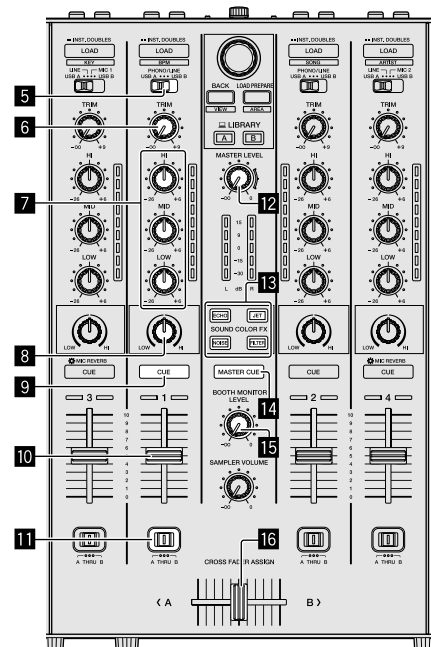

5 Input select switch

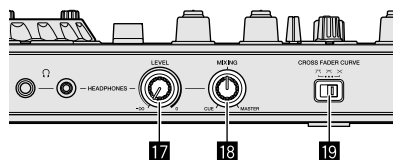

- 6 TRIM control
- 7 EQ (HI, MID, LOW) controls
- 8 COLOR control
- 9 Headphones CUE button
- 10 Channel fader
- 11 CROSS FADER ASSIGN switch
- 12 MASTER LEVEL control
- 13 SOUND COLOR FX buttons
- 14 MASTER CUE button
- 15 BOOTH MONITOR LEVEL control
- 16 Crossfader
- 17 HEADPHONES LEVEL control
- 18 HEADPHONES MIXING control
- 19 CROSS FADER CURVE switch

Set the positions of the controls, etc., as shown below.

Names of controls, etc.	Position
MASTER LEVEL control	Turned fully counterclockwise
TRIM control	Turned fully counterclockwise
EQ (HI, MID, LOW) controls	Center
COLOR control	Center
Channel fader	Moved forward
CROSS FADER ASSIGN switch	[THRU] position
Input select switch	[USB A] or [USB B] position

- 1 Press the [▶/II] button to play the track.



- 2 Move the channel fader away from you.
- 3 Turn the [TRIM] control.
Adjust [TRIM] so that the orange indicator on the channel level indicator lights at the peak level.
- 4 Turn the [MASTER LEVEL] control to adjust the audio level of the speakers.
Adjust the sound level output from the [MASTER OUT 1] and [MASTER OUT 2] terminals to an appropriate level.

Monitoring sound with headphones

Set the positions of the controls, etc., as shown below.

Names of controls, etc.	Position
HEADPHONES MIXING control	Center
HEADPHONES LEVEL control	Turned fully counterclockwise

- 1 Press the headphones [CUE] button for the channel 1.

- 2 Turn the [HEADPHONES LEVEL] control.

Adjust the sound level output from the headphones to an appropriate level.



Note

This unit and the Serato DJ Pro software include a variety of functions enabling individualistic DJ performances. For details on the respective functions, see "Advanced operation" (p.20) and the Serato DJ Pro software manual.

- This unit's operating instructions can be downloaded from the Pioneer DJ operating site. For details, see "Viewing the Operating Instructions" (p.3).
- The Serato DJ Pro software manual can be downloaded from "Serato.com". For details, see "Downloading the Serato DJ Pro software manual" (p.3).

Quitting the system

- 1 Quit Serato DJ Pro.

When the software is closed, a message for confirming that you want to close it appears on the PC/Mac screen. Click [Yes] to close.

- 2 Press the [⏻ STANDBY/ON] switch on this unit's rear panel to set this unit to standby.

- 3 Disconnect the USB cable from your PC/Mac.

Connection example

Connecting input terminals

Rear panel

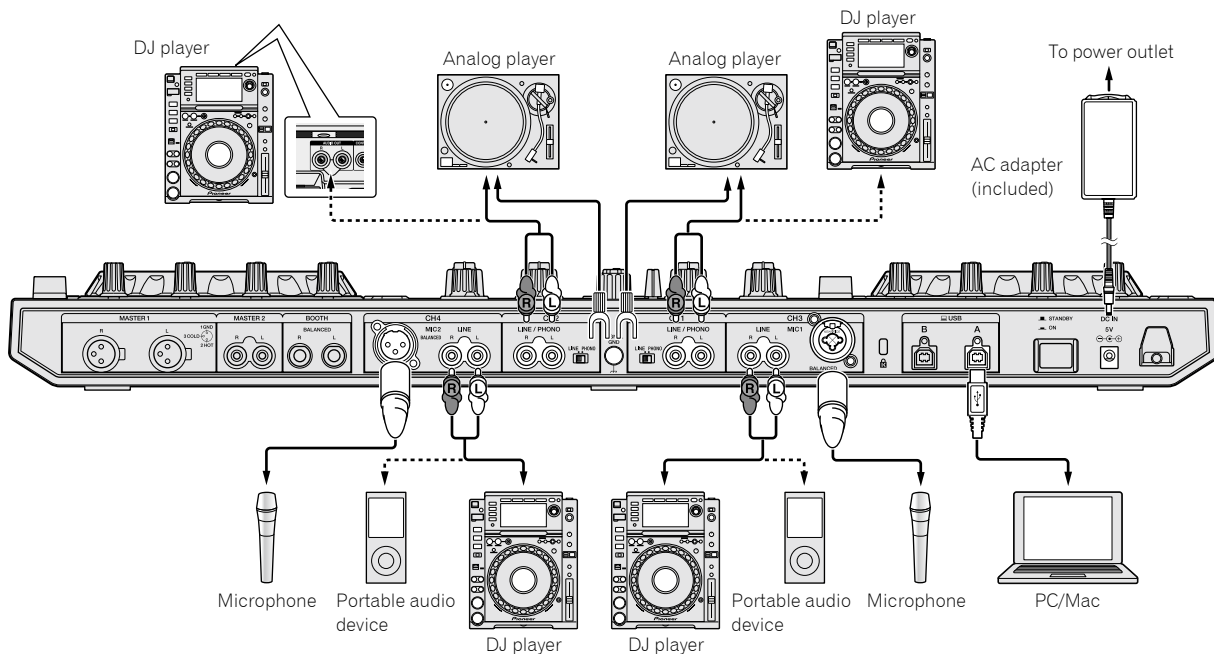

Connecting output terminals

Rear panel

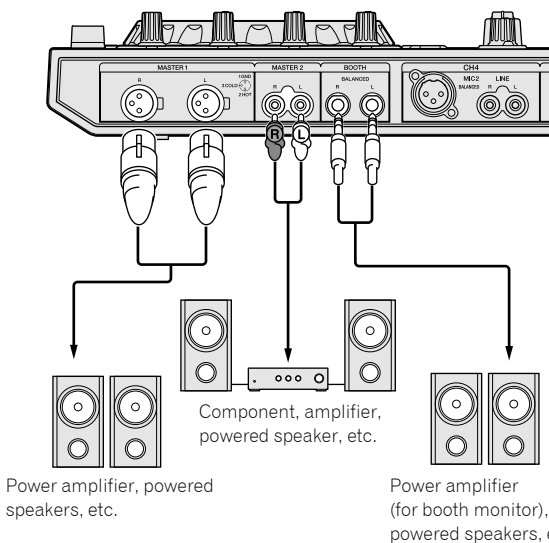

Front panel

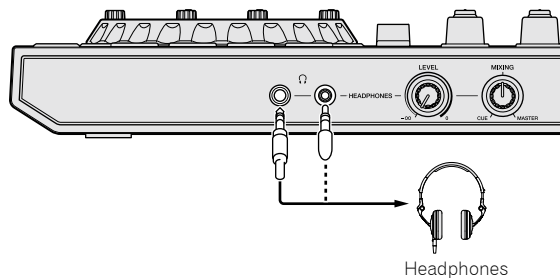

Cord hook

Hook the AC adapter's power cord.

Fasten the AC adapter's power cord in place by hooking it on the cord hook. This prevents the power cord from being accidentally pulled and the plug from being disconnected from the terminal.

- Do not fasten with the base of the AC adapter's power cord bent. If used continuously under these conditions, the power cord may be damaged, resulting in faulty contact.
- The sound will be interrupted if the AC adapter is disconnected during playback.

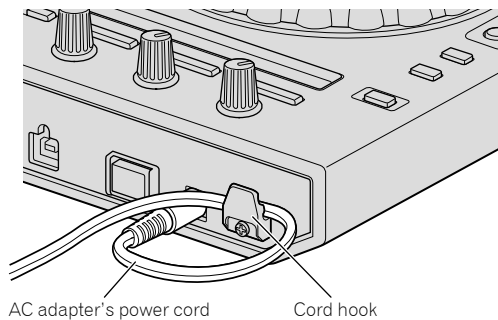

Advanced operation

From here, this guide explains the unique function when this unit and Serato DJ Pro are connected. This is not explained in the Serato DJ Pro software manual.

Using the performance pads

These functions are switched using the respective pad mode buttons (the [HOT CUE] mode button, [ROLL] mode button, [SLICER] mode button and [SAMPLER] mode button).

Using hot cues

Playback can be started from the position at which a hot cue is set.

- Up to 8 hot cue points can be set and saved per track.

1 Press the [HOT CUE] mode button.

The mode switches to the hot cue mode.

2 In the play or pause mode, press a pad to set the hot cue point.

The hot cue points are assigned to the respective pads as shown below.

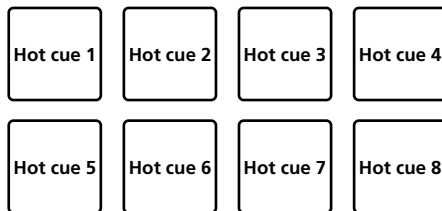

3 Press the pad at which the hot cue point was set.

Playback starts from the hot cue point.

- Hot cue points can be cleared by pressing a pad while pressing the [SHIFT] button.

Using the Roll function

When a performance pad is pressed, a loop with the number of beats assigned to that pad is set and loop playback continues as long as the pad is being pressed.

During loop roll playback, normal playback with the original rhythm continues in the background. When loop roll playback is canceled, playback resumes from the position reached in the background at the point loop roll playback was canceled.

1 Press the [ROLL] mode button.

The mode switches to roll mode.

2 Press the [PARAMETER◀] or [PARAMETER▶] button.

The loop roll beats assigned to the performance pads switch each time one of the buttons is pressed.

The following 4 settings can be made:

- 1: 4 beats from 1/32
- 2: 8 beats from 1/16
- 3: 16 beats from 1/8
- 4: 32 beats from 1/4

For example, when set to "8 beats from 1/16", the pad's setting is as shown below.



The range of beats set for the loop roll is displayed on the PC/Mac screen.



3 Press and hold one of the performance pads.

A loop roll with the number of beats assigned to the pad that was pressed is played.

Playback continues in the background during loop roll playback.

- The number of beats of the currently playing loop roll can be changed by pressing the [LOOP 1/2X] or [LOOP 2X] button during loop roll playback.

4 Release the performance pad.

Loop roll playback is canceled, and playback resumes from the position reached in the background.

Using the Slicer function

The specified range is divided into 8 equal sections, and these 8 sliced sections are assigned to the respective performance pads. While one of the performance pads is pressed, the sound for the section assigned to that pad is played in a loop.

During loop playback of the pad's sound, normal playback with the original rhythm continues in the background. When the pad is released and loop playback ends, playback resumes from the position reached at that point.

- The slicer function cannot be used with tracks for which no beatgrid is set. For details on setting beatgrids, see the Serato DJ Pro software manual.

1 Press the [SLICER] mode button.

The mode switches to slicer mode.

- While pressing the [SHIFT] button, pressing the [SLICER] mode button switches the mode to slicer loop mode.

☞ "About slicer mode and slicer loop mode" (p.21)

2 Press the [PARAMETER◀] or [PARAMETER▶] button while pressing the [SHIFT] button.

Set the domain for the slicer function. The value set for the domain switches each time one of the buttons is pressed while pressing the [SHIFT] button.

The domain can be set to one of 6 settings: 2 beats, 4 beats, 8 beats, 16 beats, 32 beats or 64 beats.

The 8 equal sections into which the range specified with the domain setting have been sliced are assigned to the respective performance pads as shown below.

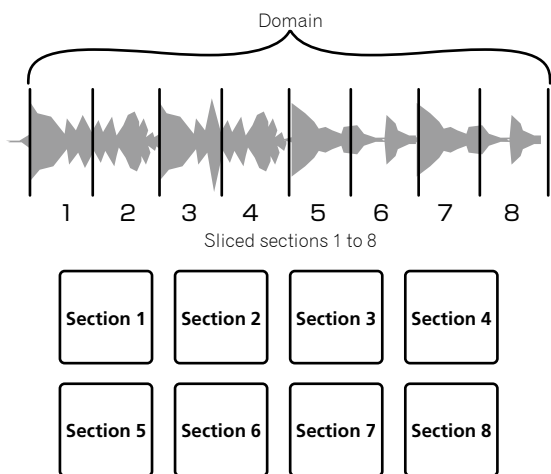

3 Press the [PARAMETER◀] or [PARAMETER▶] button.

Set the quantization for the slicer function. The value set for the quantization switches each time one of the buttons is pressed. The quantization can be set in 4 ways: 1/8, 1/4, 1/2 and 1. The length of the loop which is played while the pad is being pressed can be changed with the "QUANTIZATION" setting. For example, when "QUANTIZATION" is set to "1", the entire section assigned to the pad is played in a loop, and when "QUANTIZATION" is set to "1/2", only the first half of the section assigned to the pad is played in a loop.

4 Press and hold one of the performance pads.

When the pad is pressed and held, the sound is played in a loop.

- The length of loop playback differs depending on the quantization setting.

When the pad is released, the track returns to the position that is playing in the background.

❖ About slicer mode and slicer loop mode

Slicer mode

When the playback position advances to the end of the range that has been sliced into 8 equal sections, the range shown on the display switches to the next 8 sliced sections, and these sliced sections are assigned to the respective pads, replacing the previously assigned sections.

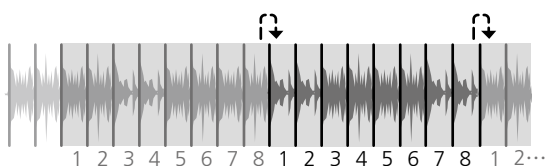

Slicer loop mode

When the playback position advances to the end of the range that was sliced into 8 equal parts, the playback position returns to the beginning of the range that was sliced into 8 equal parts.

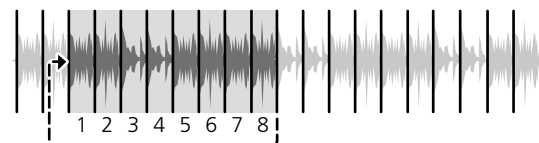

Using the sampler function

Tracks loaded in the sampler slots of the sampler can be played with the performance pads.

1 Open the [SAMPLER] panel on the PC/Mac screen with the mouse operation.

2 Press the [SAMPLER] mode button.

The mode switches to the sampler mode.

3 Press the [PARAMETER◀] or [PARAMETER▶] button.

Switch the sampler bank. The sampler has 4 banks, A, B, C and D, and each bank has 8 slots.

4 Drag and drop tracks to load them into the [SAMPLER] panel's slots with the mouse operation on the PC/Mac screen.

The sampler settings and loaded tracks are saved.

5 Press a performance pad.

The sound for the slot assigned to the pad that was pressed is played.

- Playback method differs depending on the Serato DJ Pro sampler mode. For details, see the Serato DJ Pro software manual.

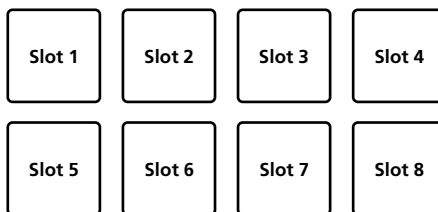

- When a performance pad is pressed while pressing the [SHIFT] button, the sound of the slot that is currently playing stops.

Using the cue loop

1 Press the [HOT CUE] mode button while pressing the [SHIFT] button.

The mode switches to cue loop mode.

2 During playback, press a performance pad.

The loop in point is set at the hot cue slot and loop playback starts.

- The length of the loop at this time is the number of beats set for auto looping. The loop in points are assigned to the performance pads as shown below.

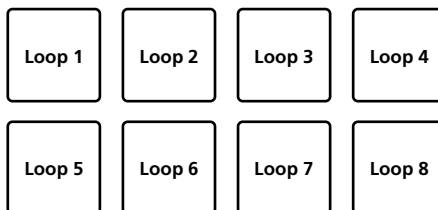

- With the cue loop function, the hot cue point is used as the loop-in point. If a performance pad at which a hot cue point is already set is pressed, loop playback starts from that hot cue point.

3 During loop playback, press the [PARAMETER◀] button.

The loop playback length becomes half.

Pressing the [LOOP 1/2X] button obtains the same effect.

4 During loop playback, press the [PARAMETER▶] button.

The loop playback length becomes double.
Pressing the [LOOP 2X] button obtains the same effect.

5 During loop playback, press the [LOOP 1/2X] or [LOOP 2X] button while pressing the [SHIFT] button.

The loop moves, remaining the same length (loop shift).

6 While pressing the [SHIFT] button, press the same performance pad.

The track returns to the set loop in point and loop playback continues.

7 Press the same performance pad again.

Loop playback is canceled.

Using the saved loop

With this function, loop is saved in a loop slot of Serato DJ Pro and the saved loop is called.

1 Press the [ROLL] mode button while pressing the [SHIFT] button.

The mode switches to saved loop mode.

2 During loop playback, press a performance pad.

A loop is assigned to the loop slot of Serato DJ Pro.

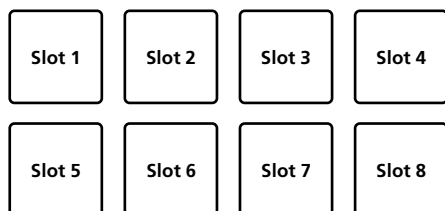

3 Press the performance pad while pressing the [SHIFT] button.

Playback continues by returning to the beginning of the loop.

4 Press the same performance pad again.

Loop playback is canceled.

5 During loop playback, press the [PARAMETER◀] button.

The loop playback length becomes half.

6 During loop playback, press the [PARAMETER▶] button.

The loop playback length becomes double.

7 During loop playback, press the [LOOP 1/2X] or [LOOP 2X] button while pressing the [SHIFT] button.

The loop moves, remaining the same length (loop shift).

- When the loop shift function is used, if the length of the called loop is changed, the loop setting is overwritten and saved.

Using the pitch play

To use this function, activation for the Pitch'n Time function is required. For details, refer to "Serato Pitch'n Time Manual" in [Software Info] on the following Pioneer DJ support site.
pioneerdj.com/support/

1 Press the [SAMPLER] mode button while pressing the [SHIFT] button.

The mode switches to the pitch play mode.

2 Press the performance pad while pressing the [SHIFT] button to select a registered hot cue point.

3 Press the performance pad.

To select the pitch range from up range, middle range or down range, press the [PARAMETER◀] button or [PARAMETER▶] button.

With the pitch assigned by pressing the pad, playback starts from the hot cue point selected in step 2.

Up range



Middle range

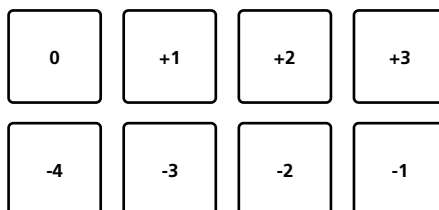

Down range

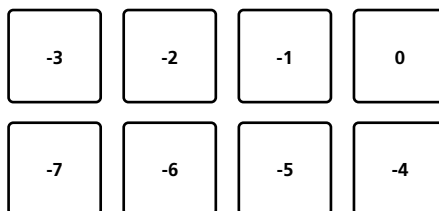

Using the Serato Flip

Serato Flip can record and call sequences such as hot cue operations. For details on operation of Serato Flip, refer to [Software Info] of [DDJ - SX3] on the following Pioneer DJ support site.
pioneerdj.com/support/

Creating a Flip

1 Click the Flip tab to display the Flip slot on the Serato DJ Pro screen.

2 Press the [FLIP REC] button to get ready to record the Flip.

3 Play a track and operate Hot Cue.

Flip recording starts at when hot cue operation is started.

4 Press the [FLIP REC] button again to stop recording the Flip.

Saving a Flip into the slot

1 Press the [FLIP SLOT] button to select the saving slot for the Flip.

The slot is changed by each pressing the button.

2 Press the [FLIP SLOT] button while pressing the [SHIFT] button.

The Flip is saved into the slot.

- You can also save the Flip into the slot using a performance pad. For details, refer to "Using Saved Flip" (p.23).

Calling the Flip saved in slot and playing it

1 Press the [FLIP SLOT] button to select the slot saved with the Flip.

The slot is changed by each pressing the button.

2 Press the [FLIP REC] button while pressing the [SHIFT] button.

Select on/off of the Flip loop operation.

- When Flip slot loop on slot screen and Flip loop on the Flip panel are highlighted, the Flip is looped.
- If there is an unsaved flip in the temporary area, the loop of the Flip in the temporary area is turned on/off. If Flip in the temporary area is saved in an empty slot, the loop of the Flip in the selected slot is turned on/off.

3 Press the [FLIP START] button.

Flip is called and played from the beginning.

- If there is an unsaved Flip in the temporary area, the Flip in the temporary area is called. If Flip in the temporary area is saved in the empty slot, Flip in the selected slot is called. The called Flip is moved to the beginning and is played.
- If you press the [FLIP START] button while pressing the [SHIFT] button or press the [PARAMETER▶] button while pressing the [SHIFT] button, you can turn on the flip without moving to the beginning of the Flip. In this case, Flip will be played when the playback position of the track reaches at the beginning of the Flip.
- You can also call the Flip in the slot with a performance pad. For details, see "Using Saved Flip" (p.23).

Moving to the beginning of the Flip during Flip playback

Press the [FLIP START] button.

During Flip playback, playback position is moved at the beginning of the Flip by each pressing the button.

Quitting Flip

Press the [FLIP START] button while pressing the [SHIFT] button.

The Flip playback is ended and normal playback returns.

Using Saved Flip

- During DUAL DECK mode, Saved Flip cannot be used.

Saving the created flip into the slot using the performance pad

1 Follow the procedure in "Creating a Flip" (p.22) to create a Flip.

2 Press the [HOT CUE] mode button for 1 second or longer.

The mode switches to SAVED FLIP mode.

- Press the button again to switch to the hot cue mode.

3 Press the performance pad.

The Flip is saved in the slot.

- Flip cannot be saved depending on the performance pad when the slot is full. To delete the flip of the slot, click the Flip slot delete button on the slot screen.

Calling Flip of slot using a performance pad to play

1 Press the [HOT CUE] mode button for 1 second or longer.

The mode switches to the SAVED FLIP mode.

2 Press the performance pad.

The Flip of the corresponding slot is called. The called Flip moves to the beginning of the Flip and is played.

- When pressing the performance pad while pressing the [SHIFT] button, Flip of the corresponding slot is called, but it is not moved to the beginning of that Flip. In this case, Flip is played when the playback position of the track reaches at the beginning of the Flip.

Moving to the beginning of the Flip using a performance pad during Flip playback

During Flip playback, the playback position is moved at the beginning of the Flip by each pressing a performance pad.

Quitting Flip using a performance pad

During Flip playback, press the performance pad while pressing the [SHIFT] button.

The Flip playback is stopped, and normal playback returns.

Using the edit grid

1 Press the [ROLL] mode button for 1 second or longer.

2 On the Serato DJ Pro screen, click [EDIT GRID] to display the edit grid screen

3 Press the performance pad or parameter button to control the [EDIT GRID] screen of Serato DJ Pro.

Using the slip

When the slip is set to on, normal playback is continued while maintaining the original rhythm in the background during scratch playback, loop playback, or hot cue playback. When scratch playback, loop playback, or hot cue playback is canceled, normal playback resumes from the position elapsed until cancel. Various performances are possible without breaking the rhythm.

- For the default setting, the **[SLIP]** button lights up when the slip mode is on, and flashes while continuing playback in the background.

Slip Hot Cue

1 Press the **[HOT CUE]** mode button.

The mode switches to the hot cue mode.

2 Set the Hot Cue.

To set the hot cue, press the performance pad.

3 Press the **[SLIP]** button.

The mode switches to the slip mode.

4 Press and hold the performance pad during playback.

Playback starts from the position where the Hot Cue is set. Playback continues while pressing the performance pad.

Normal playback continues in the background during Hot Cue playback.

5 Release your finger from the performance pad.

Playback starts from the position advanced in the background.

- To cancel the slip mode, press the **[SLIP]** button again.

Slip scratch play

1 Make sure the **VINYL** mode is on.

Make sure that the **[SLIP]** button lights up while pressing the **[SHIFT]** button.

2 For Scratch play, operate the top of the jog wheel during playback.

Normal playback continues in the background during scratch play.

3 Release your finger from the top of the jog wheel.

Playback starts from the position advanced in the background.

- To cancel the slip mode, press the **[SLIP]** button again.

❖ To check if the **VINYL** mode is on or off

By the default, the **VINYL** mode is on, so you can operate the scratch play. You can check the current status with the lighting status of the **[SLIP]** button while pressing the **[SHIFT]** button.

- When the **VINYL** mode is on, the **[SLIP]** button lights while pressing the **[SHIFT]** button.
- When the **VINYL** mode is off, the **[SLIP]** button lights off while pressing the **[SHIFT]** button.

To turn on/off the **VINYL** mode, press the **[SLIP]** button while pressing the **[SHIFT]** button.

Slip breaking

1 Adjust the **[Braking]** - **[Stop Time]** setting in the **[DJ Preference]** tab of the **[SETUP]** menu.

The **[Braking]** setting adjusts the speed from the playback of the track until it stops. When using the slip braking, adjust the **[Stop Time]** control of **[Braking]** on the PC/Mac screen to around 9 o'clock to set it to stop slowly.

2 Press the **[SLIP]** button.

The mode switches to the slip mode.

3 Press the **[PLAY / PAUSE ►/II]** button during playback.

Playback stops slowly. Normal playback continues in the background while slowly stopping.

4 Press the **[PLAY/PAUSE ►/II]** button again.

Playback starts from the position advanced in the background.

- To cancel the slip mode, press the **[SLIP]** button again.

Slip auto loop

1 Press the **[SLIP]** button.

The mode switches to the slip mode.

2 Press the **[LOOP 1/2X]** button or the **[LOOP 2X]** button.

Select the beat of the auto loop.

3 Press the **[AUTO LOOP]** button.

A loop is set with the specified beat number and loop playback starts. Normal playback continues in the background during loop playback.

4 Press the **[AUTO LOOP]** button again.

The loop is canceled and playback starts from the position advanced in the background.

- To cancel the slip mode, press the **[SLIP]** button again.

Slip manual loop

❖ Creating a loop and slipping it

1 Press the **[SLIP]** button.

The mode switches to the slip mode.

2 Press the **[LOOP IN]** button, and then press the **[LOOP OUT]** button.

Loop playback starts.

Normal playback continues in the background during loop playback.

3 Press the **[LOOP OUT]** button while pressing the **[SHIFT]** button.

The loop is canceled and playback starts from the position advanced in the background.

- To cancel the slip mode, press the **[SLIP]** button again.

❖ Slipping a loop using the loop slot

1 Press the **[SLIP]** button.

The mode switches to the slip mode.

2 To select a loop to play, press the **[LOOP IN]** button while pressing the **[SHIFT]** button.

3 Press the **[LOOP OUT]** button while pressing the **[SHIFT]** button.

Loop playback starts.

Normal playback continues in the background during loop playback. Hold down the **[SHIFT]** button until the next operation.

4 While pressing the **[SHIFT]** button, press the **[LOOP OUT]** button again.

The loop is canceled and playback starts from the position advanced in the background.

- To cancel the slip mode, press the **[SLIP]** button again.

Using DUAL DECK mode

DUAL DECK mode is a function allowing you to control both decks simultaneously when mixing two different tracks on deck 1 and deck 3 (or on deck 2 and deck 4). A feature of this function is that it enables such operations as scratching, looping and hot cueing of two different tracks that have been mixed by mashing them up or blending them, as if they were a single track.

The explanation below describes an example of the operation for controlling decks 1 and 3 simultaneously.

1 Press the [DECK3] button while pressing the [DECK1] button, or press the [DECK1] button while pressing the [DECK3] button.

DUAL DECK mode turns on, the [DECK] button, which was pressed first, flashes, and the [DECK] button, which was pressed later, lights.

Status display in the dual deck mode

- When entering DUAL DECK mode, the deck status of the [DECK] button, which was pressed first, is displayed.

2 Press the [DECK1] or [DECK3] button.

DUAL DECK mode turns off, and the [DECK] button lights.

The controller switches to the deck of the pressed [DECK] button.

Functions that can be controlled in DUAL DECK mode

The following functions can be controlled on the two decks simultaneously in DUAL DECK mode.

Button or control that is operated	Function
Jog wheel	Scratch, pitch bend, skip mode, slip scratch
SLIP button	Slip mode, VINYL mode
KEY LOCK button	Key lock, tempo reset
AUTO LOOP button	Auto loop, active loop, auto slip loop
LOOP 1/2X button	Auto loop beat selection, half loop, loop shift
LOOP 2X button	Auto loop beat selection, double loop, loop shift
LOOP IN button	Loop in, loop in adjust, loop slot selection, manual slip loop
LOOP OUT button	Loop out, loop out adjust, re-loop/exit, manual slip loop
HOT CUE mode button	Hot cue mode, Cue loop mode
ROLL mode button	Roll mode, Saved loop mode
SLICER mode button	Slicer mode, Slicer loop mode
Performance pads	Hot cue trigger, Hot cue deletion, Slip hot cue, Loop roll trigger, Slicer trigger, Cue loop trigger, Saved loop trigger
PARAMETER◀ button, PARAMETER▶ button	Loop roll beat selection, SLICER QUANTIZATION selection, SLICER DOMAIN selection, Loop half, Loop double, Loop shift
PLAY/PAUSE ▶/II button	Play, pause, slip braking
CUE button	Cue setting, back cue, cue sampler
SYNC button	Sync, sync off
CENSOR button	Censor, reverse
NEEDLE SEARCH pad	Needle search
FLIP REC button	Sequence loop
FLIP START button	Sequence start, Sequence on
FLIP SLOT button	Sequence slot selection
KEY UP/SYNC button	Key up, key sync
KEY DOWN/RESET button	Key down, key reset

❖ Functions that are limited in DUAL DECK mode

In DUAL DECK mode, the following functions can only be operated on the deck where the [DECK] button is flashing.

Button or control that is operated	Function
TEMPO slider	Tempo adjustment
KEY LOCK button	Tempo range
FLIP REC button	Sequence REC

❖ Deck status mirroring function

When the following modes are in the different status for each deck, the status is automatically set to the one in which the [DECK] button is flashing.

- Vinyl mode status, pad mode status, slip mode status

Using the fader start function

Using the channel fader start function

1 Set the cue.

Pause at the position from which you want to start playback, then press the [CUE] button for the corresponding deck.

- Cues can also be set by moving the channel fader from the back to the position nearest you while pressing the [SHIFT] button in the pause mode.

2 While pressing the [SHIFT] button, move the channel fader from the position nearest you towards the back.

Playback of the track starts from the set cue point.

- When the channel fader is moved back to the position nearest you while pressing the [SHIFT] button during playback, the track moves instantaneously back to the set cue point and the pause mode is set. (Back Cue)
- If no cue is set, playback starts from the beginning of the track.
- It is also possible to change the setting in utilities mode so that the sync mode is set simultaneously when playback is started with the channel fader start function.
- When the channel fader is moved from the back to the position nearest you while pressing the [SHIFT] button when standing by at a cue, track playback starts from the set cue.

Using the crossfader start function

To use the crossfader start function, set the [CROSS FADER ASSIGN] switch of the channel you want to move to [A] or [B].

1 Set the cue.

Pause at the position from which you want to start playback, then press the [CUE] button for the corresponding deck.

- Cues can also be set by moving the crossfader to the left edge or the right edge while pressing the [SHIFT] button in the pause mode.

2 Move the crossfader to the left edge or right edge position.

Set to the edge opposite the side on which the channel you want to use with the fader start function is set.

3 While pressing the [SHIFT] button, move the crossfader in the opposite direction from the left edge or right edge.

Playback of the track starts from the set cue point.

- When the crossfader is returned to the original position while pressing the [SHIFT] button during playback, the track moves instantaneously back to the set cue point and the pause mode is set (Back Cue).
- If no cue is set, playback starts from the beginning of the track.
- When the crossfader is moved from the left edge to the right edge (or from the right edge to the left edge) while pressing the [SHIFT] button when standing by at a cue, track playback starts from the set cue point.

Using the velocity sampler

When velocity sampler mode is on, the sample volume level changes according to the amount of force used to tap the performance pads. The volume level increases when the performance pads are tapped strongly and decreases when they are tapped weakly.

When velocity sampler mode is off, the sound is triggered at the volume level set using the Serato DJ Pro software, regardless of the amount of force used to tap the performance pads.

Turning the velocity sampler mode on

When the [SAMPLER] mode button is pressed for 1 second or longer, the velocity sampler mode is turned on.

Turning the velocity sampler mode off

When the [SAMPLER] mode button is pressed, the mode is changed to the usual sampler mode (velocity sampler mode is turned off).

- In the utilities mode, the velocity curve and after-touch function can be set.
 - When after-touch is enabled, the sample volume level changes while the performance pad is being pressed according to the force used to press on the pad.
 - ③ “Changing the velocity curve setting of velocity sampler mode” (p.33)
 - ③ “Enabling the after-touch setting in velocity sampler mode” (p.34)

Analyzing tracks

When tracks are loaded onto the decks by pressing the [LOAD] button on this unit, the tracks are analyzed, but it may take time to finish the analyzing tracks and to display the BPM and waveform.

When the Serato DJ Pro software is used as an offline player, tracks can be analyzed ahead of time. For tracks whose analysis has been completed, the BPM and waveform are displayed immediately when the tracks are loaded onto the decks.

For details on using the Serato DJ Pro software as an offline player and instructions on analyzing tracks, see the Serato DJ Pro software manual.

- Depending on the number of tracks, it may take time for analysis.

Using effects

Serato DJ Pro has two effects units, FX1 and FX2. Those effects can be applied to the selected deck. The following describes how to operate this unit to assign an effect unit to channel 1 (FX1).

Serato DJ Pro effects unit screen display

Multi FX mode: Up to three effects can be selected per effect unit, and each effect has one adjustable parameter.

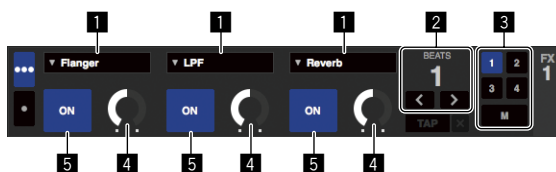

Single FX mode: One effect can be selected per effect unit and there are multiple adjustable parameters.

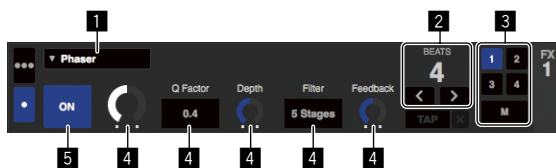

- 1 This displays the effect type.
- 2 This displays the effect time.
- 3 This displays the number of the deck to which the effect unit is assigned.
- 4 This displays the effect parameter status.
- 5 This displays whether the effect is on or off.

Operating in the multi FX mode

1 Switch the DJ-FX mode to the multi FX mode on the Serato DJ Pro screen.

Display the [FX] panel, and then click the multi FX mode.

2 Press the [CH ASSIGN] button on the left deck to select the deck to be assigned.

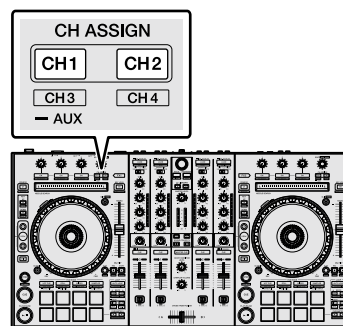

- The number of the deck to which the effect is assigned is highlighted on the Serato DJ Pro screen.

3 Press the effect parameter 1 button while pressing the [SHIFT] button to select the first effect type.

To select the second effect type, press the effect parameter 2 button while pressing the [SHIFT] button.

To select the third effect type, press the effect parameter 3 button while pressing the [SHIFT] button.

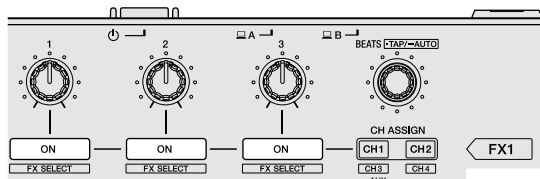

- The currently selected effect type is displayed on the Serato DJ Pro screen.

4 Press the effect parameter 1 button to turn the first effect on.

Press the effect parameter 2 button to turn the second effect on.
Press the effect parameter 3 button to turn the third effect on.

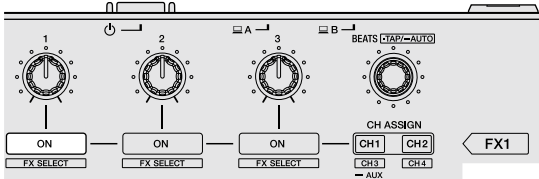

- The [ON] key for the corresponding effect is highlighted on the Serato DJ Pro screen.

5 Operate the effect parameter 1 control to adjust the parameter of the first effect.

Operate the effect parameter 2 control to adjust the parameter of the second effect.
Operate the effect parameter 3 control to adjust the parameter of the third effect.

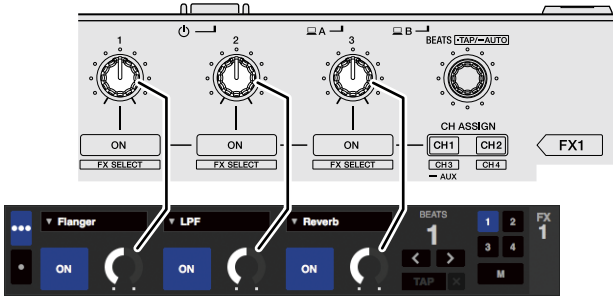

6 Turn the [FX BEATS] control to adjust the effect time.

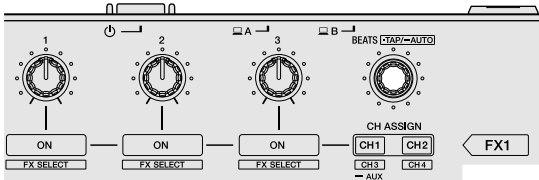

- It is also possible to set the BPM value to be used as the basis for the effect time from the interval at which the [FX BEATS] control is tapped while the [SHIFT] button is pressed.
- ➔ "Switching the effect's tempo mode" (p.28)

Operating in the single FX mode

1 Switch the DJ-FX mode to the multi FX mode on the Serato DJ Pro screen.

Display the [FX] panel, and then click the multi FX mode.

2 Press the [CH ASSIGN] button on the left deck to select the deck to be assigned.

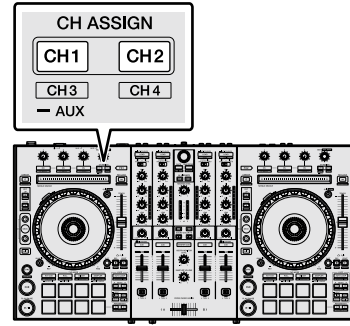

- The number of the deck to which the effect is assigned is highlighted on the Serato DJ Pro screen.

3 Press an effect parameter button while pressing the [SHIFT] button to select the effect type.

- The selected effect is displayed on the Serato DJ Pro screen.

4 Press the effect parameter 1 button to turn the effect on.

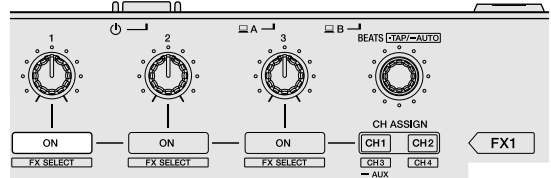

The effect switches between on and off by each pressing the button.

- The effect's [ON] key is highlighted on the Serato DJ Pro screen.

5 Operate the effect parameter 2 button or the effect parameter 3 button to switch the effect's parameter.

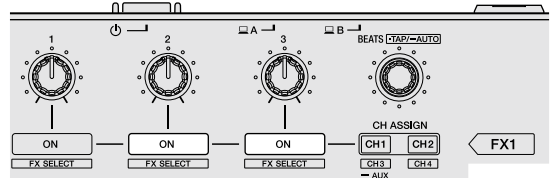

- Depending on the type of effect, the button may not light when it is operated.

6 Operate the effect parameter control(s) to adjust the effect's parameter(s).

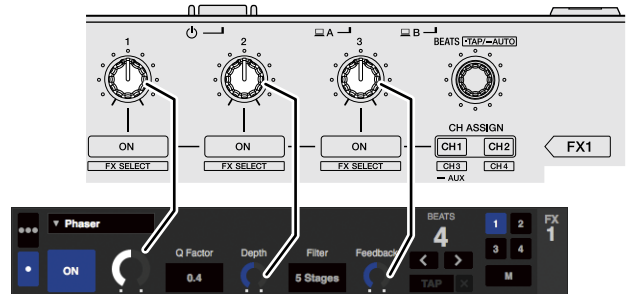

7 Turn the [FX BEATS] control to adjust the effect time.

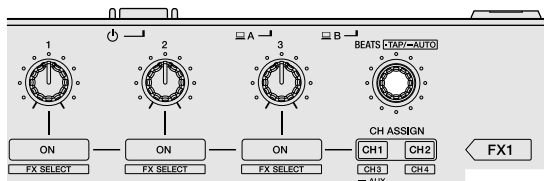

- It is also possible to set the BPM value to be used as the basis for the effect time from the interval at which the [FX BEATS] control is tapped while the [SHIFT] button is pressed.
- “Switching the effect's tempo mode” (p.28)

Switching the effect's tempo mode

With Serato DJ Pro effects, there are two ways to set the effect's tempo: with the “auto tempo mode” and the “manual tempo mode”.

- By default, the auto tempo mode is set.

❖ Auto tempo mode

The track's BPM value is used as the basis for the effect's tempo.

❖ Manual tempo mode

The BPM value used as the effect's basis is calculated from the interval at which the [FX BEATS] control is tapped while the [SHIFT] button is pressed.

❖ Switching to the manual tempo mode

While in the auto tempo mode, press the [FX BEATS] control three times or more while the [SHIFT] button is pressed.

- When [FX BEATS] control is tapped for 1 second or longer while the [SHIFT] button is pressed in the manual-tempo mode, the mode switches to the auto tempo mode.

Using SOUND COLOR FX

This effect changes with the [COLOR] control.

1 Press a [SOUND COLOR FX] button to select the effect type.

The pressed button flashes.

- Even if the [SOUND COLOR FX] button is already selected, the pressed button is selected.
- For the effect types, see “Effect types” (p.28).
- The same effect is set to all channels.

2 Turn the [COLOR] control.

The effect is added to the sound of the channel that turned the control.

Quitting SOUND COLOR FX

Press the flashing [SOUND COLOR FX] button.

The effect is canceled.

Effect types

SOUND COLOR FX types

Effect	Description	[COLOR] control
ECHO	Outputs attenuating sound slightly behind the original sound several times, and adds an echo effect.	Turn counterclockwise: The delay time of the echo sound gradually increases. Turn clockwise: The delay time of the echo sound gradually decreases.
JET	Adds a flanger effect.	Turn counterclockwise: Add a strong bass flanger effect. Turn clockwise: Add a strong treble flanger effect.
NOISE	Adds white noise.	Turn counterclockwise: The cutoff frequency of the filter that passes white noise decreases. Turn clockwise: The cutoff frequency of the filter that passes white noise rises.
FILTER	Outputs sound through the filter.	Turn counterclockwise: The cutoff frequency of the low pass filter gradually decreases. Turn clockwise: The cutoff frequency of the high pass filter gradually increases.

- The delay time of the echo sound differs depending on whether Serato DJ Pro software can receive BPM value or not. Conditions that can receive BPM value from the Serato DJ Pro software:
 - When there is BPM information on the deck loaded with music on Serato DJ Pro
 - When the input select switch is set to [USB A] or [USB B]
 When the conditions are such that the Serato DJ Pro software can receive BPM values, the delay time of the echo sound can be adjusted with the beat number.

Using external inputs / microphone

Four external input systems are provided to connect to a DJ player or analog turntable. The 4-Channel Mixer of this unit can mix externally input sounds without using a PC/Mac. The following mixer functions can be operated without connecting to a PC/Mac.



Note

- For details on the respective items, see “Basic operation” (p.14) and “Part names and functions” (p.6).
- The following functions do not work with respect to external inputs.
 - Track tempo setting (pressing the headphones [CUE] button while pressing the [SHIFT] button)
 - Fader start function (move the channel fader or cross fader while pressing the [SHIFT] button)
- The values adjusted with the various controls for the Serato DJ Pro software differ from values adjusted for the external input.

Mixer section

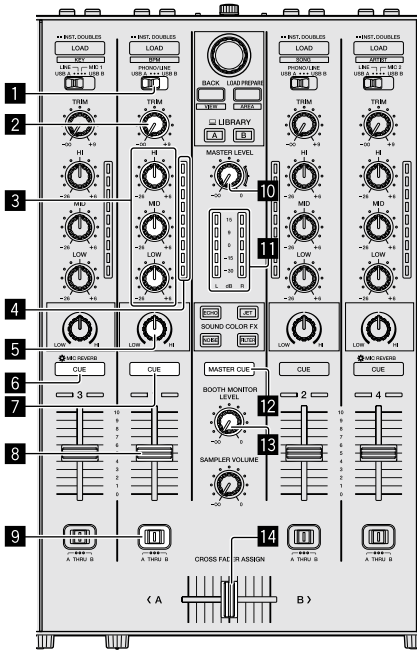

- Input select switch
- TRIM control
- EQ (HI, MID, LOW) controls
- Channel Level Indicator
- COLOR control
- Headphones CUE/MIC REVERB button
- Headphones CUE button
- Channel fader
- CROSS FADER ASSIGN switch
- MASTER LEVEL control
- Master level indicator
- MASTER CUE button
- BOOTH MONITOR LEVEL control
- Crossfader

Front panel

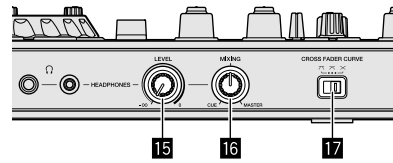

- HEADPHONES LEVEL control
- HEADPHONES MIXING control
- CROSS FADER CURVE switch

Mixing the sound of the microphone 1 or 2

1 Connect a microphone to the [MIC1] or [MIC2] terminal.

2 Set the input select switch to [MIC1] or [MIC2].

3 Turn the [TRIM] control and move the channel faders to adjust the audio level output from the respective decks.

- The sound can be adjusted with the [EQ (HI, MID, LOW)] controls, and filter effects can be applied to the respective channels with the [COLOR] control.
- The reverb function is turned on/off by pressing the headphones [CUE/MIC REVERB] button. To adjust the microphone settings such as reverb, use the setting utility. See “About the setting utility” (p.31).
- The sound volume of channels for which the input select switch is set to [MIC1] or [MIC2] does not change even when the crossfader is moved.

Mixing the sound of the microphone 3

1 Connect a microphone to the [MIC3] terminal.

2 Set the [MIC3 ON/OFF] switch to on.

3 Turn the [MIC3 LEVEL] control to adjust the audio level output.

- To adjust the microphone settings such as EQ (HI, MID, LOW), reverb, use the setting utility. See “About the setting utility” (p.31).
- The sound volume of [MIC3] does not change even when the crossfader is moved.

Mixing the sound of a DJ player, etc.

- 1 Connect the DJ player or other line level output device to the [LINE/PHONO] input terminals.
- 2 Set the input select switch to [PHONO/LINE] or [LINE].
- 3 Set the [LINE/PHONO] switch on the rear panel to [LINE].
- 4 Turn the [TRIM] control and move the channel faders to adjust the audio level output from the respective decks.
 - The sound can be adjusted with the [EQ (HI, MID, LOW)] controls, and color effects can be applied to the respective channels with the [COLOR] control.

Mixing the sound of an analog turntable, etc.

- 1 Connect the analog player or other phono level (for MM cartridges) output device to the [LINE/PHONO] terminals.
- 2 Set the input select switch to [PHONO/LINE].
- 3 Set the [LINE/PHONO] switch on the rear panel to [PHONO].
- 4 Turn the [TRIM] control and the channel faders to adjust the audio level output from the respective decks.
 - The sound can be adjusted with the [EQ (HI, MID, LOW)] controls, and color effects can be applied to the respective channels with the [COLOR] control.

Changing the settings

About the setting utility

The following settings can be changed:

- Adjust the buffer size (when using ASIO).
- Adjust the microphone settings.
- Check the driver software version.

Displaying the setting utility

For Mac

Click [Macintosh HD] icon > [Application] > [Pioneer] > [DDJ-SX3] > [DDJ-SX3 Settings Utility].

For Windows 10

Click [Start] menu > [Pioneer] > [DDJ-SX3 Settings Utility].

For Windows 8.1

In [Apps view], click the [DDJ-SX3 Settings Utility] icon.

For Windows 7

Click [Start] menu > [All Programs] > [Pioneer] > [DDJ-SX3] > [DDJ-SX3 Settings Utility].

Changing the settings

Adjusting the microphone setting

Display the setting utility before starting.

Click the [MIC] tab.

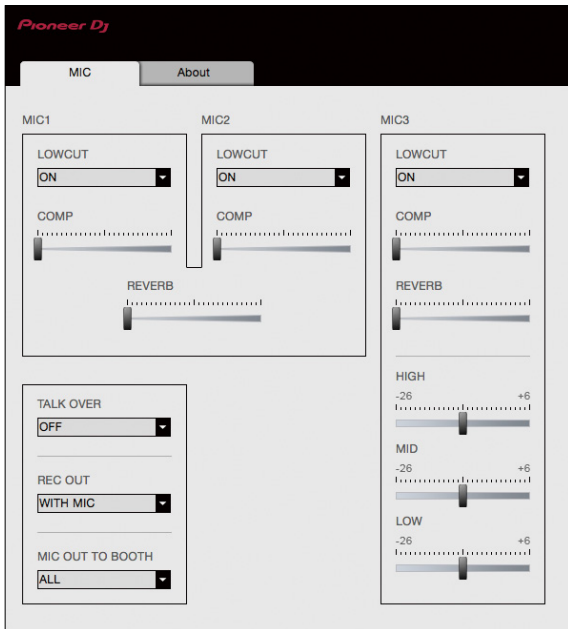

- On this screen, it is available to set for the microphone connected to this unit.

Setting item	Screen display	Description
LOW CUT FILTER	ON, OFF	Mic low cut filter
COMPRESSOR	OFF, MIN to MAX	Mic compressor
REVERB	MIN to MAX	Mic reverb

Setting item	Screen display	Description
MIC3 EQ (HIGH, MID, LOW)	-26 dB to +6 dB	Mic 3 EQ
MIC OUT TO BOOTH	OFF, MIC3, MIC1,2, ALL	Mic output to booth out
TALK OVER	OFF, MIC1, MIC2, MIC3, MIC1,2, ALL	Trigger setting of TALKOVER function
REC OUT	WITH MIC, WITHOUT MIC	Mic output to REC out

Adjusting the buffer size (when using ASIO)

This feature is only for using Windows.

If an application using this unit as the default audio device (DJ software, etc.) is running, quit that application before adjusting the buffer size. Display the setting utility before starting.

Click the [ASIO] tab.

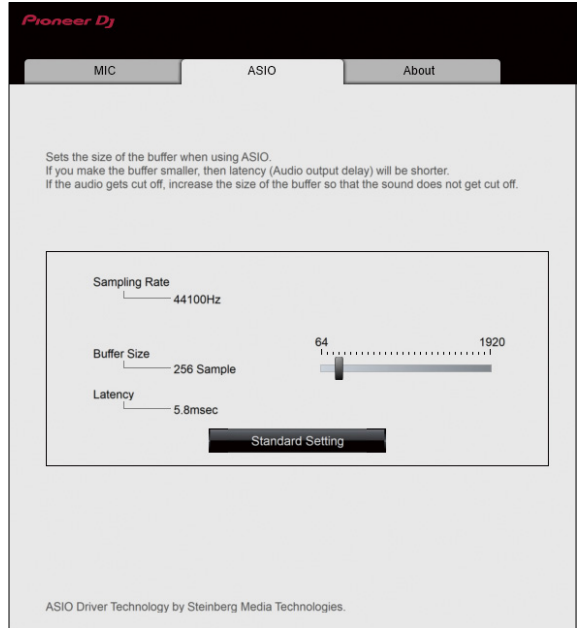

- If the buffer size is made large, drops in audio data (breaks in the sound) occur less easily, but the time lag due to the delay in the transfer of the audio data (latency) increases.

Checking the driver software version

Display the setting utility before starting.

Click the **[About]** tab.



- On this screen, it is available to check the firmware version.
- If the PC/Mac is not connected to this unit or this unit and PC/Mac cannot be communicated normally, the firmware version cannot be displayed.

Launching the utilities mode

If the utilities mode is launched while the unit and a PC/Mac are connected by a USB cable, the set status may not be displayed properly.

1 Disconnect the USB cable from the PC/Mac.

2 Press the [⏻ STANDBY/ON] switch on the rear panel to turn the unit to the standby mode.

3 While pressing the [SHIFT] button and [PLAY/PAUSE ▶/II] on the left deck, press the [⏻ STANDBY/ON] switch.

The utilities mode is launched.

4 After setting the utilities mode, operate the controller for the items whose settings you want to change.

See the explanations below for the settings that can be changed.

5 Press the [⏻ STANDBY/ON] switch to turn the unit to the standby mode.

Settings are saved and the utilities mode is quit.

Utilities modes

The following settings can be changed:

- MIDI controller setting
- Channel fader start setting
- Crossfader start setting
- Master output attenuator level setting
- Slip mode flashing setting
- [SLIP] button lit/flash operation setting

- Demo mode setting
- Velocity sampler mode velocity curve setting
- Velocity sampler mode after-touch setting
- Cut lag setting of crossfader
- Jog wheel illumination mode setting
- Back spin length setting
- Crossfader MIDI message operation setting of the crossfader
- Launching the setting utility automatically

Forcefully using the unit as the general MIDI controller

The unit automatically changes operation as follows depending on whether Serato DJ Pro is running.

- When Serato DJ Pro is running, this unit can be operated as a controller according to the Serato DJ Pro functions.
- When Serato DJ Pro is not running, the unit can be operated as a general MIDI controller.

Even though Serato DJ Pro is running, you can forcefully operate the unit as a general MIDI controller.

Press the [HOT CUE] or [ROLL] mode button on the right deck.

- [HOT CUE] mode button lit: Operation automatically changes depending on whether or not Serato DJ Pro is running.
- [ROLL] mode button lit: Regardless of whether or not Serato DJ Pro is running, the unit is forcefully operated as a general MIDI controller.

Changing the channel fader start setting

The channel fader start function's setting can be changed.

- By default, the channel fader start mode function without the sync mode is set.

Press an effect parameter button on the left deck.

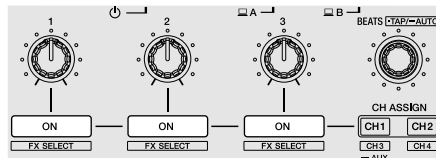

- Effect parameter 1 button lit: Channel fader starts with the sync mode set. (The sync function is activated simultaneously when channel fader starting starts.)
- Effect parameter 2 button lit: Channel fader starts without the sync mode set. (The sync function is not activated when channel fader starting starts.)
- Effect parameter 3 button lit: Channel fader start function is disabled.

Changing the crossfader start setting

The crossfader start function settings can be changed.

- By default, the crossfader start mode functions without sync mode is set.

Press an effect parameter button on the right deck.

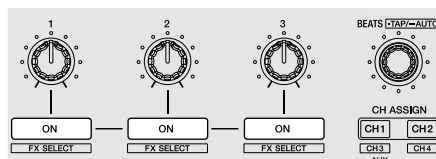

- Effect parameter 1 button lit: Crossfader starts with the sync mode set. (The sync function is activated simultaneously when crossfader starting starts.)

- Effect parameter 2 button lit: Crossfader starts without the sync mode set. (The sync function is not activated simultaneously when crossfader starting starts.)
- Effect parameter 3 button lit: Crossfader start function is disabled.

Setting the master output's attenuator level

- By default, 0 dB is set.

Press a [HOT CUE] mode, [ROLL] mode or [SLICER] mode button on the left deck.

- [HOT CUE] mode button lit: 0 dB (no attenuation)
- [ROLL] mode button lit: -3 dB
- [SLICER] mode button lit: -6 dB

Changing the slip mode flashing setting

When the slip mode is on, the buttons that can be operated in the slip mode (jog wheel indicator, [AUTO LOOP] button, [PLAY/PAUSE ►/II] button, etc.) flash. This setting can be used to disable the flashing of these buttons.

- By default, slip mode flashing is enabled.

Press the [SLIP] button on the left deck.

- [SLIP] button lit: Slip mode flashing is enabled.
- [SLIP] button off: Slip mode flashing is disabled.

Setting the [SLIP] button lit/flash operation

By default, the [SLIP] button lights when the mode switches to the slip mode and flashes while playback is continuing in the background. With this setting, the [SLIP] button can be made to flash when Slip mode is started, regardless of whether or not normal playback continues while the original rhythm is maintained in the background.

Press the [SLIP] button on the right deck.

- [SLIP] button lit: The [SLIP] button flashes upon entering slip mode.
- [SLIP] button off: The [SLIP] button lights upon entering slip mode and the [SLIP] button flashes while normal playback is continued while the original rhythm is maintained in the background.

Changing the demo mode setting

On this unit, the demo mode is set if no operation is performed for 10 minutes under normal usage conditions. This demo mode can be changed.

- By default, demo mode starts when there is no operation for 10 minutes.
- When any control or button on this unit is operated while in the demo mode, the demo mode is canceled.

Press the [AUTO LOOP] button on the right deck.

The demo mode setting changes each time the [AUTO LOOP] button is pressed.

The currently set value is indicated by how the [LOOP 1/2X], [LOOP 2X], [LOOP IN] and [LOOP OUT] buttons light.

- [LOOP 1/2X] button lights: Demo mode is disabled.
- [LOOP 2X] button lights: Demo mode starts when there is no operation for 1 minute.
- [LOOP IN] button lights: Demo mode starts when there is no operation for 5 minutes.
- [LOOP OUT] button lights: Demo mode starts when there is no operation for 10 minutes.

Changing the velocity curve setting of velocity sampler mode

Set the velocity curve of velocity sampler mode. You can choose one of four velocity curves.

- By default, curve 3 is set.

Press the [AUTO LOOP] button on the left deck.

The velocity curve setting changes by each pressing the [AUTO LOOP] button.

The currently set value is indicated by how the [LOOP 1/2X], [LOOP 2X], [LOOP IN] and [LOOP OUT] buttons light.

Curve 1

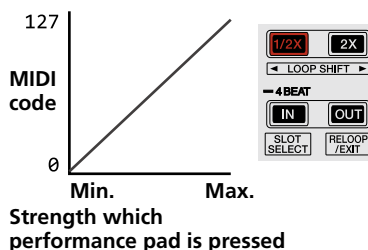

Curve 2

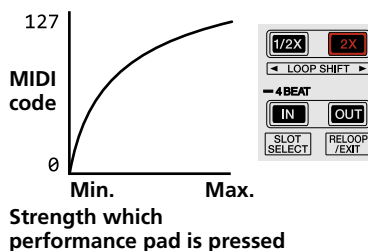

Curve 3

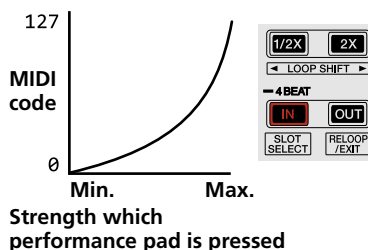

Curve 4

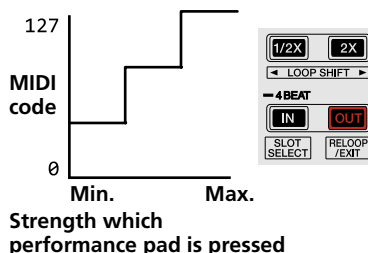

Enabling the after-touch setting in velocity sampler mode

When the velocity sampler mode is turned on for this unit's performance pads, the after touch setting can be turned on/off.

After touch setting disabled: The sampler volume changes according to the strength with which the performance pad is initially pressed, but does not keep changing while the pad is held after it is initially pressed.
 After touch setting enabled: The sampler volume changes according to the strength with which the performance pad is initially pressed and the strength with which the pad is held after it is initially pressed.

- By default, the after touch setting is disabled.

Press the [SAMPLER] mode button on the left deck.

- [SAMPLER] mode button lit: After touch setting is enabled.
- [SAMPLER] mode button off: After touch setting is disabled.

Adjusting the crossfader cut lag

Adjust the cut lag on both edges of the crossfader. It can be adjusted between 0 (0.5 mm) and 52 (5.7 mm) in increments of 0.1 mm.

- The above cut lag position for the cut lag setting is a guide and it may not match the position at which the sound volume becomes zero.
- By default, 5 (1 mm) is set.

Turn the rotary selector.

The current setting (0 to 52) is displayed by the lit condition of the channel level indicator.

- Number of lit segments of the [CH3] channel level indicator: Ten's place
- Number of lit segments of the [CH1] channel level indicator: One's place

Changing illumination mode in the white area of the jog wheel

You can adjust the lit pattern of the white area of the illumination around the jog wheel center part.

- The illumination can be set for decks 1 and 2 and decks 3 and 4, separately.
- By default, decks 1 and 2 are set to pattern 2 and decks 3 and 4 are set to pattern 4.

Press any of performance pads 1 to 5 of the left deck (right deck).

The illumination at the center of the jog wheel lights once around. The current setting is indicated by how the performance pads light.
 When a performance pad on the left side deck is pressed, illumination for decks 1 and 2 is set. When a performance pad on the right side deck is pressed, illumination for decks 3 and 4 is set.

Pattern 1

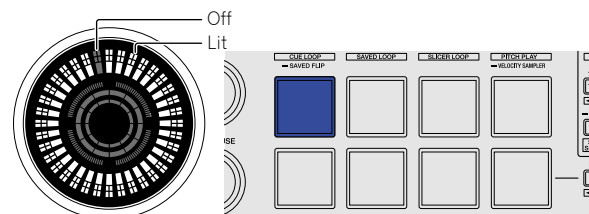

Pattern 2

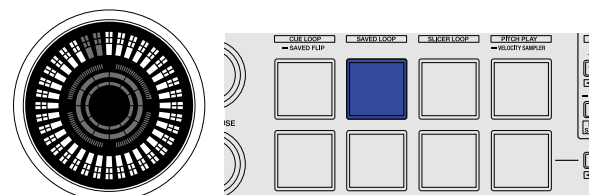

Pattern 3

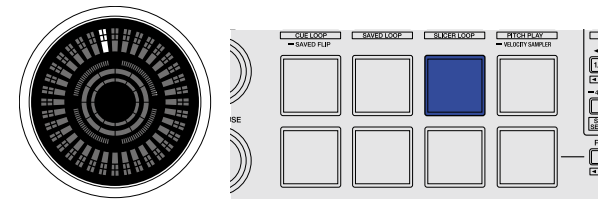

Pattern 4

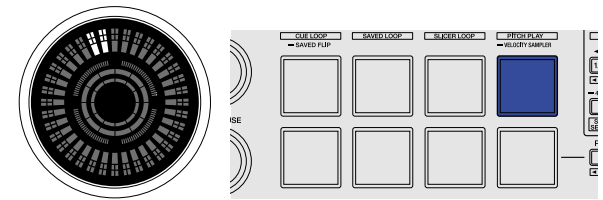

Pattern 5

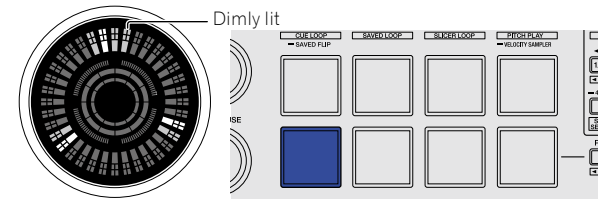

Switching the illumination mode in the red area of the jog wheel

The light of the red area of illumination in the center part of the jog wheel can be set to the hot cue countdown or slip mode status display.

- By default, hot cue countdown is set.

Press the performance pad 6 or 7 on the left deck.

Pad 6 lit: Lights when the track playback position comes close to the hot cue point. (Hot cue countdown)
 Pad 7 lit: Lights or flashes in the same way as the [SLIP] button.

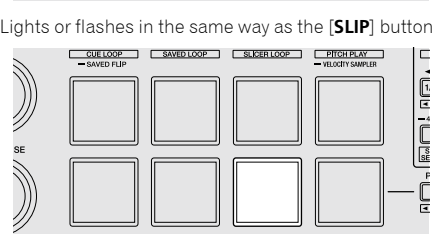
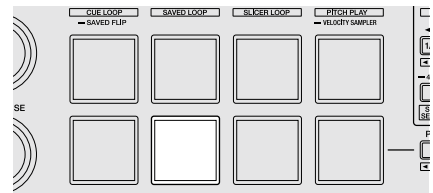

Switching the backspin length

It is possible to make the unit perform back spin longer than the actual jog wheel rotation amount when back spin operation of jog wheel is performed.

The length of back spin operation can be selected from one of three types: short, normal, and long.

- By default, back spin length normal is set.

Press any of performance pads 6 to 8 on the right deck.

Pad 6 lit: Back spin length normal

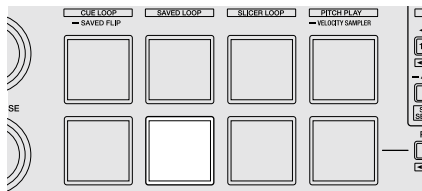

Pad 7 lit: Back spin length short

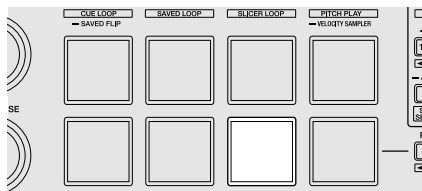

Pad 8 lit: Back spin length long

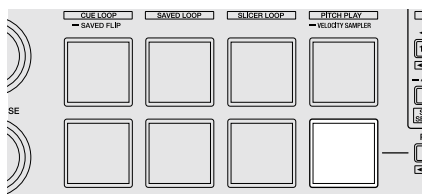

Disabling optimization of crossfader MIDI messages

When the [CROSS FADER CURVE] switch on the front panel is set to , the crossfader MIDI messages output method is optimized to improve crossfader response during scratching.

With this setting, optimization of crossfader MIDI messages is disabled.

- By default, optimization of crossfader MIDI messages is enabled.
- Optimization of crossfader MIDI messages is performed only when the [CROSS FADER CURVE] switch is set to .

Press the [KEY LOCK] button on the left deck.

- [KEY LOCK] button lit: Optimization of crossfader MIDI messages is enabled.
- [KEY LOCK] button off: Optimization of crossfader MIDI messages is disabled.

Launching the setting utility software automatically

When connecting the USB cable to PC/Mac, the setting utility software on the PC/Mac can be launched automatically.

By default, the setting utility software is not launched automatically.

Press the [KEY LOCK] button on the right deck.

- [KEY LOCK] button lit: the setting utility software is launched automatically.
- [KEY LOCK] button off: the setting utility software is not launched automatically.

Adjusting the sensitivity of the jog wheel touch sensor

This unit is equipped with a mode for adjusting the sensitivity of the jog wheel touch sensor.

- The value set in the jog wheel sensitivity adjustment mode is retained even when this unit is turned off.
- The sensitivity of the left and right jog wheel can be adjusted separately.

The following example describes the procedure for adjusting the sensitivity of the jog wheel on the left deck.

1 Connect this unit to the PC/Mac via an included USB cable.

2 Press the [DECK1] or [DECK3] button while pressing the [SHIFT] button.

The sensitivity adjustment mode is set, and the current sensitivity is displayed on the indicator in the center area of the jog wheel.

- During the sensitivity adjustment mode, perform the next operation within 3 seconds. (If more than 3 seconds pass after a button was pressed, the set value is stored and the indicator returns to the normal display.)

3 Press the [DECK1] or [DECK3] button while pressing the [SHIFT] button.

The sensitivity increases each time the [DECK1] button is pressed and decreases each time the [DECK3] button is pressed.

When the jog wheel sensitivity is adjusted, the set sensitivity is displayed on the indicator in the center area of the jog wheel.

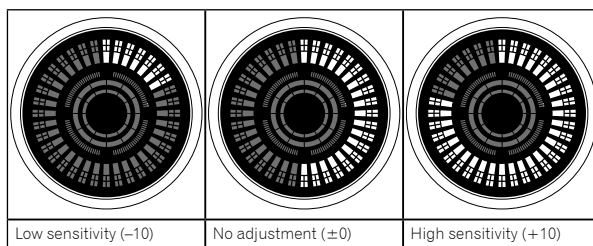

The jog wheel sensitivity can be adjusted in 37 steps.

- By default, "No adjustment (±0)" is set.
- To adjust the sensitivity of the jog wheel on the right side, press the [DECK2] or [DECK4] button while pressing the [SHIFT] button.

4 After setting is completed, wait for 3 seconds.

When 3 seconds have passed after pressing the button, the set value is stored and the indicator returns to the normal display.

Additional information

Troubleshooting

- If you think that there is something wrong with this unit, check the items below. Also access the Pioneer DJ site and check **[FAQ]** for the **[DDJ-SX3]** in the **[FAQ]** page.
pioneerdj.com/
Sometimes the problem may lie in another component. Inspect the other components and electrical appliances being used. If the problem cannot be rectified, ask your nearest Pioneer authorized service center or your dealer to carry out repair work.
- This unit may not operate properly due to static electricity or other external influences. In this case, proper operation may be restored by unplugging the USB cable, then plugging it back in.

Problem	Check	Remedy
The power is not turned on.	Is the [STANDBY/ON] switch of the power on?	Turn the [STANDBY/ON] switch of the power on.
	Is the included AC adapter properly connected?	Mount the power plug properly on the included AC adapter. Connect the included AC adapter properly to the power outlet. (p.14) Connect the included AC adapter's DC plug properly to this unit.
This unit is not recognized.	Is the included USB cable properly connected?	Connect the included USB cable properly.
	Are you using a USB hub?	USB hubs cannot be used. Connect the PC/Mac and this unit directly using the included USB cable.
	Is the driver software properly set?	Set the driver software properly. (p.3)
	Is your PC/Mac recognizing the unit?	In [DDJ-SX3 Settings Utility] , check if the firmware version of this unit is displayed. (p.31)
	Are other applications running?	Quit other applications including screen savers and resident software. (When quitting antivirus security software, before doing so, disable the Internet connection to ensure the security of your PC/Mac.)
	Are USB devices other than this unit connected?	Remove external hard disks and the keyboard (for some models), etc. to check the status with only the built-in hard disk.
	—	If your PC/Mac has more than one USB terminal, check using a different USB terminal.
	Are multiple ASIO drivers for units other than this unit installed on the PC/Mac?	Uninstall unnecessary ASIO drivers. For details of how to uninstall ASIO drivers, check with the manufacturer of the respective ASIO driver.
The jog wheel does not respond to touching.	Is the sound setting on the PC/Mac set properly?	Mac: After disconnecting the USB cable from Mac, start the Audio MIDI setting and display the MIDI window. Select the [DDJ-SX3] icon, and then click [Remove Device] . (The icon may be displayed as [USB MIDI Device] instead of [DDJ-SX3] . In this case, select [USB MIDI Device] .) When connecting the USB cable again, the [DDJ-SX3] is displayed.
	Is the jog wheel dirty?	An electrostatic system is used as the detection method in the jog wheel of this unit. Therefore, if the jog wheel is dirty or the user has hand cream on their hands, detection may not respond. When cleaning the jog wheel, dry wipe with a soft cloth. If it is very dirty, prepare a 5:1 or 6:1 solution of water and neutral detergent, immerse a soft cloth in the solution and wring out well, then clean the jog wheel and wipe with a dry cloth after that.
	Is the touch sensor sensitivity of the jog wheel set appropriately?	Use the utilities mode to adjust the touch sensor sensitivity of the jog wheel. (p.35)
Tracks are not displayed in the library panel.	Does the jog wheel respond when touched while touching some other metal part of the unit?	If touching the jog wheel while touching some other metal part of the unit makes it work, there is a possibility that the unit is affected by another device connected to the unit. Review the connection environment (setting location or ground connection status, etc.) of the devices (PC/Mac, amplifier, etc.) connected to the unit.
	Have music files been imported?	Import the music files properly. For details on importing music files, refer to the Serato DJ Pro software manual.
iTunes tracks are not displayed in the library panel.	Is a crate or subcrate that does not contain any tracks selected?	Either select a crate or subcrate that contains tracks or add tracks to the crate or subcrate.
	Is [Show iTunes Library] at the [Library + Display] tab in the [SETUP] menu checked?	Tick the [Show iTunes Library] check box. If [Show iTunes Library] is already selected, clear the check mark and then tick it again. For details on importing music files, refer to the Serato DJ Pro software manual.
Music files in the library cannot be edited (changing track names, etc.).	Is a crate or subcrate that does not contain any tracks selected?	Either select a crate or subcrate that contains any tracks or add tracks to the crate or subcrate.
	Is [Protect Library] at the [SETUP] menu's [Library + Display] tab enabled?	Disable [Protect Library] .
Recording is not possible.	Is the recording level low?	Adjust the gain control on the [REC] panel in the Serato DJ Pro software.
	Have you saved the recording after completing it?	Save the recording after completing it. For detailed instructions on recording, see the Serato DJ Pro software manual.

Problem	Check	Remedy
No sound or little sound.	Are the [TRIM] control, channel faders, crossfader and [MASTER LEVEL] control set to the proper positions?	Set the [TRIM] control, channel faders, crossfader, input select switch, and [MASTER LEVEL] control to the proper positions.
	Is the connected powered speakers, etc., properly set?	Properly set the external input selection, volume, etc., on the powered speakers, etc.
	Are the connection cables properly connected?	Connect the connection cables properly.
	Are the terminals and plugs dirty?	Clean the terminals and plugs before making connections.
	Is the driver software properly set?	Set the driver software properly. (p.3)
Distorted sound.	Is the [MASTER LEVEL] control set to the proper position?	Adjust the [MASTER LEVEL] control so that the master level indicator's orange indicator lights at the peak level.
	Is the [TRIM] control set to the proper position?	Adjust the [TRIM] control so that the channel level indicator's orange indicator lights at the peak level.
Sound being played is interrupted when using DJ software.	Is the buffer size (latency) value appropriate?	For Windows, use the ASIO setting utility to set an appropriate buffer size value. (p.31) For Mac, set the appropriate buffer size (latency) value for the DJ software.
	Is the input select switch set to the proper position?	Set the input select switch to the proper position.
Sound of an external device or microphone cannot be output.	Is the input select switch set to the proper position?	Set the input select switch to the proper position.
The indicator flashes and operation is unusual.	—	Normal operation can be restored by disconnecting the AC adapter, waiting at least 1 minute, then reconnecting the AC adapter. If the same symptom persists, disconnect the AC adapter, and then request repairs.
Serato DJ Pro operation is unstable.	Are you using the latest version of the software?	Free updates of Serato DJ Pro can be downloaded from the website. Use the most recent version. (p.3)
	Are you using softwares other than Serato DJ Pro at the same time?	Quit other applications to decrease the load on the PC/Mac. If operation continues to be unstable, try disabling the wireless network or other wireless connections, antivirus software, screen saver, low power mode, etc. (p.3)
	Is another USB device connected to the PC/Mac?	Disconnect other USB devices from the PC/Mac. When another USB audio device is connected to the PC/Mac at the same time, it may not operate or be recognized normally.
	Are you using a USB hub?	USB hubs cannot be used. Connect the PC/Mac and this unit directly using the included USB cable.
	Is there a problem with the USB port to which this unit is connected?	If your PC/Mac has multiple USB ports, try connecting this unit to a different USB port.
	Is this unit connected to a notebook PC/Mac running on its battery?	Supply power to the notebook PC/Mac from an AC power supply. (Depending on the notebook PC/Mac settings, the low power mode may be set when the computer is running on its battery, automatically reducing the performance of the PC/Mac itself.) (p.3)
	Is the USB buffer size too small?	Raise the USB buffer size. (p.31)
The fader start function does not work.	Has a temporary cue been set?	Set a temporary cue.
	Is the [CROSS FADER ASSIGN] switch for the channel that you wish to start outputting from set to [A] or [B] ? (For crossfader start)	Set the [CROSS FADER ASSIGN] switch for the channel that you wish to start outputting from to [A] or [B] .
The BPM is not displayed. The sync and auto loop functions do not work.	Has the track been analyzed?	Analyze the track.
	Is [Set Auto BPM] checked in the offline player settings?	Re-analyze the track with [Set Auto BPM] checked. For detailed instructions on analyzing tracks, refer to the Serato DJ Pro software manual.
The BPM is displayed but not the beatgrid. The slicer function does not work. The skip mode does not work.	Are [Set Auto BPM] and [Set Beatgrid] checked in the offline player settings?	Re-analyze the track with [Set Auto BPM] and [Set Beatgrid] checked. For detailed instructions on analyzing tracks, see the Serato DJ Pro software manual.
		Set the beatgrid. For detailed instructions on setting the beatgrid, see the Serato DJ Pro software manual.
The BPM and beatgrid are not displayed properly. The beatgrid is off beat.	Is the BPM analysis range set appropriately in the offline player settings?	Change the BPM analysis range then reanalyze the tracks. If the problem persists, set the beatgrid and BPM manually.
		Adjust the beatgrid. For detailed instructions on adjusting the beatgrid, see the Serato DJ Pro software manual.
		During playback of the track and while pressing the [SHIFT] button, tap the headphones [CUE] or headphones [CUE/MIC REVERB] button in beat (Tap function). The track's BPM and beat grid can be adjusted. When the tap function is used, the deck section's display on the PC/Mac screen switches to the [Beatgrid Editor] display. To switch the deck section's display back to how it was before, click [Edit Grid] on the PC/Mac screen.
After jog wheel rotation stops, the track playback position may advance in the rotation direction for a while.	Is the back spin length of the utilities mode set to standard or long?	Set the back spin length of the utilities mode to short. When the jog wheel rotation stops, playback pauses or becomes normal playback at the position.
The Serato DJ Pro virtual deck is not displayed (off-line player is displayed).	Is the pad mode button and [DECK] button lit?	If the pad mode button and [DECK] button does not light, connection with the PC/Mac is not properly established. Connect the included USB cable correctly.
	Are you using the latest version of the Serato DJ Pro software?	Update the software to the latest version.

Problem

Jog illumination does not rotate during playback or it rotates but is not synchronized with the Serato DJ Pro virtual deck. When the deck is switched, the [TEMPO] slider operation does not work.

Check

In the utilities mode, is the unit set to be forcefully operated as a general MIDI controller?

Remedy

In the utilities mode, set the mode with which the operation of the unit is automatically switched according to whether or not Serato DJ Pro is running.

Audio Block Diagram

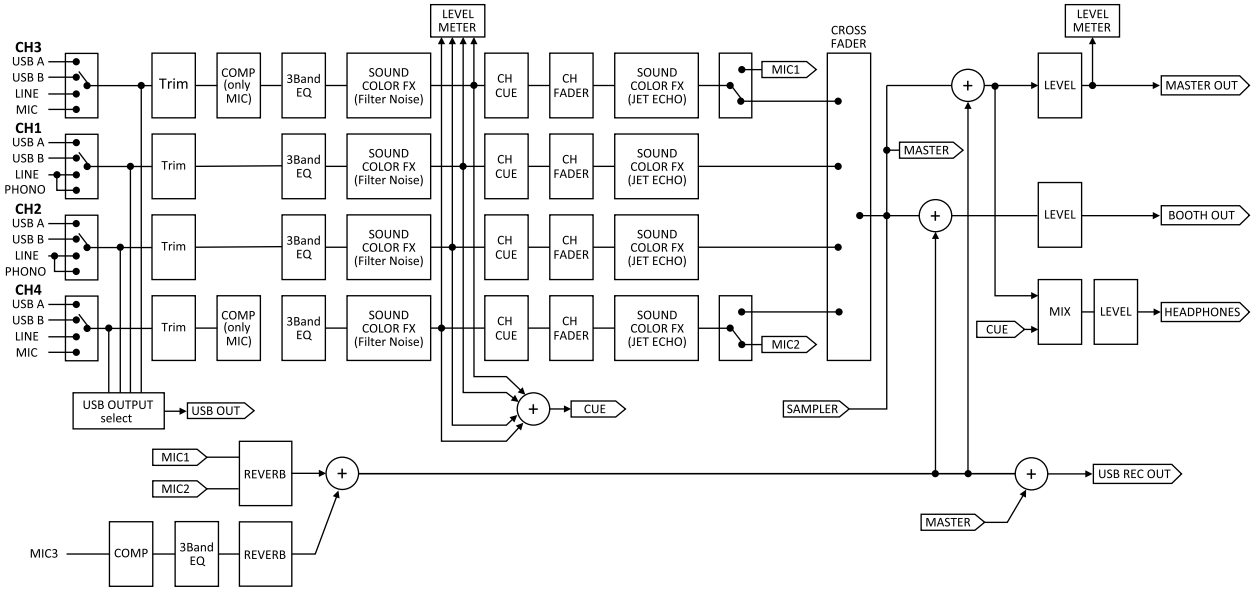

Using as a controller for other DJ software

This unit also outputs the operating data for the buttons and controls in MIDI format. If you connect a PC/Mac with a built-in MIDI-compatible DJ software via a USB cable, you can operate the DJ software on this unit. The sound of music files being played on the PC/Mac can also be output from this unit.

To use as a controller for operating DJ software other than the Serato DJ Pro software, also make the DJ software's audio and MIDI-related settings.

- For details, refer to your DJ software's operating instructions.

About MIDI messages

For details on this unit's MIDI messages, see "List of MIDI Messages".

- "List of MIDI Messages" can be acquired from the following URL: pioneerdj.com/support/

About the driver software

This driver software is an exclusive ASIO driver for outputting audio signals from the PC/Mac.

Operating environment

Supported operating systems

Mac: macOS High Sierra 10.13 / macOS Sierra 10.12, OS X 10.11 (latest update)	✓
Windows: Windows® 10 / Windows® 8.1 / Windows® 7 (latest service pack)	32-bit version ✓
	64-bit version ✓

Checking the latest information on the driver software

For detailed information on this unit's designated driver software, see the Pioneer DJ support site below.
pioneerdj.com/support/

About the installation procedure

- For the operating procedure, see "Installing the software" (p.3).

❖ Software end user license agreement

This Software End User License Agreement ("Agreement") is between you (both the individual installing the Program and any single legal entity for which the individual is acting) ("You" or "Your") and PIONEER CORPORATION ("Pioneer").

TAKING ANY STEP TO SET UP OR INSTALL THE PROGRAM MEANS THAT YOU ACCEPT ALL OF THE TERMS OF THIS LICENSE AGREEMENT. PERMISSION TO DOWNLOAD AND/OR USE THE PROGRAM IS EXPRESSLY CONDITIONED ON YOUR FOLLOWING THESE TERMS. WRITTEN OR ELECTRONIC APPROVAL IS NOT REQUIRED TO MAKE THIS AGREEMENT VALID AND ENFORCEABLE. IF YOU DO NOT AGREE TO ALL OF THE TERMS OF THIS AGREEMENT, YOU ARE NOT AUTHORIZED TO USE THE PROGRAM AND MUST STOP INSTALLING IT OR UNINSTALL IT, AS APPLICABLE.

1 DEFINITIONS

- 1 "Documentation" means written documentation, specifications and help content made generally available by Pioneer to aid in installing and using the Program.
- 2 "Program" means all or any part of Pioneer's software licensed to You by Pioneer under this Agreement.

2 PROGRAM LICENSE

- 1 Limited License. Subject to this Agreement's restrictions, Pioneer grants to You a limited, non-exclusive, non-transferable, license (without the right to sublicense):
 - a To install a single copy of the Program in Your computer or mobile device, to use the Program only for Your personal purpose complying with this Agreement and the Documentation ("Authorized Use");
 - b To use the Documentation in support of Your Authorized Use; and
 - c To make one copy of the Program solely for backup purposes, provided that all titles and trademark, copyright and restricted rights notices are reproduced on the copy.
- 2 Restrictions. You will not copy or use the Program or Documentation except as expressly permitted by this Agreement. You will not transfer, sublicense, rent, lease or lend the Program, or use it for third-party training, commercial time-sharing or service bureau use. You will not Yourself or through any third party modify, reverse engineer, disassemble or decompile the Program, except to the extent expressly permitted by applicable law, and then only after You have notified Pioneer in writing of Your intended activities.
- 3 Ownership. Pioneer or its licensor retains all right, title and interest in and to all patent, copyright, trademark, trade secret and other intellectual property rights in the Program and Documentation, and any derivative works thereof. You do not acquire any other rights, express or implied, beyond the limited license set forth in this Agreement.
- 4 No Support. Pioneer has no obligation to provide support, maintenance, upgrades, modifications or new releases for the Program or Documentation under this Agreement.

3 WARRANTY DISCLAIMER

THE PROGRAM AND DOCUMENTATION ARE PROVIDED "AS IS" WITHOUT ANY REPRESENTATIONS OR WARRANTIES, AND YOU AGREE TO USE THEM AT YOUR SOLE RISK. TO THE FULLEST EXTENT PERMISSIBLE BY LAW, PIONEER EXPRESSLY DISCLAIMS ALL WARRANTIES OF ANY KIND WITH RESPECT TO THE PROGRAM AND DOCUMENTATION, WHETHER EXPRESS, IMPLIED, STATUTORY, OR ARISING OUT OF COURSE OF PERFORMANCE, COURSE OF DEALING OR USAGE OF TRADE, INCLUDING ANY WARRANTIES OF MERCHANTABILITY, FITNESS FOR A PARTICULAR PURPOSE, SATISFACTORY QUALITY, ACCURACY, TITLE OR NON-INFRINGEMENT.

4 EXPORT CONTROL AND COMPLIANCE WITH LAWS AND REGULATIONS

You may not use or otherwise export or re-export the Program except as authorized by United States law and the laws of the jurisdiction in which the Program was obtained. In particular, but without limitation, the Program may not be exported or re-exported (a) into any U.S.-embargoed countries or (b) to anyone on the U.S. Treasury Department's Specially Designated Nationals List or the U.S. Department of Commerce Denied Persons List or Entity List. By using the Program, you represent and warrant that you are not located in any such country or on any such list.

You also agree that you will not use the Program for any purposes prohibited by United States law, including, without limitation, the development, design, manufacture, or production of nuclear, missile, or chemical or biological weapons.

5 U.S. GOVERNMENT RESTRICTED RIGHTS

The Program and Documentations are "commercial computer software" and "commercial computer software documentation" as those terms are defined in 48 C.F.R. §252.227-7014 (a) (1) (2007) and 252.227-7014 (a) (5) (2007). The U.S. Government's rights with respect to the Program and Documentations are limited by this license pursuant to 48 C.F.R. § 12.212 (Computer software) (1995) and 48 C.F.R. §12.211 (Technical data) (1995) and/or 48 C.F.R. §227.7202-3, as applicable. As such, the Program and Documentations are being licensed to the U.S. Government end users:

(a) only as "commercial items" as that term is defined in 48 C.F.R. §2.101 generally and as incorporated in DFAR 212.102; and (b) with only those limited rights as are granted to the public pursuant to this license. Under no circumstance will the U.S. Government or its end users be granted any greater rights than we grant to other users, as provided for in this license. Manufacturer is 6F, Yokohama i-Mark Place, 4-4-5 Minatomirai, Nishi-ku, Yokohama, Kanagawa 220-0012 Japan

6 DAMAGES AND REMEDIES FOR BREACH

You agree that any breach of this Agreement's restrictions would cause Pioneer irreparable harm for which money damages alone would be inadequate. In addition to damages and any other remedies to which Pioneer may be entitled, You agree that Pioneer may seek injunctive relief to prevent the actual, threatened or continued breach of this Agreement.

7 TERMINATION

Pioneer may terminate this Agreement at any time upon Your breach of any provision. If this Agreement is terminated, You will stop using the Program, permanently delete it from your computer or mobile device where it resides, and destroy all copies of the Program and Documentation in Your possession, confirming to Pioneer in writing that You have done so. Sections 2.2, 2.3, 2.4, 3, 4, 5, 6, 7 and 8 will continue in effect after this Agreement's termination.

8 GENERAL TERMS

- 1 Limitation of Liability. In no event will Pioneer or its subsidiaries be liable in connection with this Agreement or its subject matter, under any theory of liability, for any indirect, incidental, special, consequential or punitive damages, or damages for lost profits, revenue, business, savings, data, use, or cost of substitute procurement, even if advised of the possibility of such damages or if such damages are foreseeable. In no event will Pioneer's liability for all damages exceed the amounts actually paid by You to Pioneer or its subsidiaries for the Program. The parties acknowledge that the liability limits and risk allocation in this Agreement are reflected in the Program price and are essential elements of the bargain between the parties, without which Pioneer would not have provided the Program or entered into this Agreement.
- 2 The limitations or exclusions of warranties and liability contained in this Agreement do not affect or prejudice Your statutory rights as consumer and shall apply to You only to the extent such limitations or exclusions are permitted under the laws of the jurisdiction where You are located.
- 3 Severability and Waiver. If any provision of this Agreement is held to be illegal, invalid or otherwise unenforceable, that provision will be enforced to the extent possible or, if incapable of enforcement, deemed to be severed and deleted from this Agreement, and the remainder will continue in full force and

effect. The waiver by either party of any default or breach of this Agreement will not waive any other or subsequent default or breach.

- 4 No Assignment. You may not assign, sell, transfer, delegate or otherwise dispose of this Agreement or any rights or obligations under it, whether voluntarily or involuntarily, by operation of law or otherwise, without Pioneer's prior written consent. Any purported assignment, transfer or delegation by You will be null and void. Subject to the foregoing, this Agreement will be binding upon and will inure to the benefit of the parties and their respective successors and assigns.
- 5 Entire Agreement. This Agreement constitutes the entire agreement between the parties and supersedes all prior or contemporaneous agreements or representations, whether written or oral, concerning its subject matter. This Agreement may not be modified or amended without Pioneer's prior and express written consent, and no other act, document, usage or custom will be deemed to amend or modify this Agreement.
- 6 You agree that this Agreement shall be governed and construed by and under the laws of Japan.

About trademarks and registered trademarks

- "Pioneer DJ" is a trademark of PIONEER CORPORATION, and is used under license.
 - Windows is a registered trademark of Microsoft Corporation in the United States and other countries.
 - Mac, macOS, OS X and Finder are trademarks of Apple Inc., registered in the U.S. and other countries.
 - Intel and Intel Core are trademarks of Intel Corporation in the U.S. and/or other countries.
 - Adobe and Reader are either registered trademarks or trademarks of Adobe Systems Incorporated in the United States and/or other countries.
 - Serato DJ Pro is a registered trademark of Serato Limited.
 - ASJO is a trademark of Steinberg Media Technologies GmbH.
- The names of companies and products mentioned herein are the trademarks of their respective owners.

This product has been licensed for nonprofit use. This product has not been licensed for commercial purposes (for profit-making use), such as broadcasting (terrestrial, satellite, cable or other types of broadcasting), streaming on the Internet, Intranet (a corporate network) or other types of networks or distributing of electronic information (online digital music distribution service). You need to acquire the corresponding licenses for such uses. For details, refer to <http://www.mp3licensing.com>.

Cautions on copyrights

Recordings you have made are for your personal enjoyment and according to copyright laws may not be used without the consent of the copyright holder.

- Music recorded from CDs, etc., is protected by the copyright laws of individual countries and by international treaties. It is the full responsibility of the person who has recorded the music to ensure that it is used legally.
- When handling music downloaded from the Internet, etc., it is the full responsibility of the person who has downloaded the music to ensure that it is used in accordance with the contract concluded with the download site.

The specifications and design of this product are subject to change without notice.

© 2018 Pioneer DJ Corporation.
All rights reserved.
<DR11542-A>