

Technical Data

Speaker Type: Active bass-reflex subwoofer

Acoustics

Usable Bandwidth [-10 dB]: 42 Hz - Cut Freq

Frequency Response [-6dB]: 45 Hz - Cut Freq

Max SPL (1 m): 134 dB

LF: 18"

LF Voice Coil: 4"

Amplifier

Amp Technology: Digipro® G3

Power supply: Auto-range

Amp Class: Class-D

RMS Power: 900 W

Peak Power: 1800 W

Cooling: Passive (convection)

Operating voltage :

100-120V~ 50-60 Hz

220-240V~ 50-60 Hz

Processor

AD/DA Converter: 24 bit / 48 kHz

Controller: DSP 28/56 bit

Controls

Input sensitivity, Polarity, Delay rotary, Xover/Link frequency

Input/Output

Mains connections: PowerCON® TRUE1 In/link

Signal Input: (Balanced) 1x IN (female)

Signal Out: (Balanced) Link/Xover OUT (male)

RDNET connectors: Data In / Data Out

USB connector: standard USB B-type (for SERVICE DATA)

Mechanics

Housing: Wooden box

Width: 720 mm (28.3 in)

Height: 530 mm (20.8 in)

Depth: 690 mm (27.1 in)

Weight: 41.8 kg (92.1 lbs)



POWER SUPPLY SPECIFICATIONS (POWER ABSORPTION)

Draw at 1/8 of full power in average use conditions (*): 1.2 A (220-240V~) - 2 A (100-120V~)

Draw at 1/3 of full power in maximum use conditions (**): 2.7 A (220-240V~) - 4.7 A (100-120V~)

Power absorption with speaker turned on without signal (idle): 19 W

* INSTALLER NOTES: The values refer to 1/8 of full power, in average operating conditions (music program with infrequent or no clipping). It is recommended to consider them the minimum sizing values for any type of configuration.

** INSTALLER NOTES: The values refer to 1/3 of full power, in heavy operating conditions (music program with frequent clipping or activation of the limiter). We recommend sizing according to these values in case of professional installations and tours.

Scan with your QR Reader
App to download the
complete User Manual

EMI CLASSIFICATION

According to the standards EN 55103 this equipment is designed and suitable to operate in E3 (or lower E2, E1) Electromagnetic environments.

FCC CLASS B STATEMENT ACCORDING TO TITLE 47, PART 15, SUBPART B, §15.105

This equipment has been tested and found to comply with the limits for a Class B digital device, pursuant to part 15 of the FCC Rules. These limits are designed to provide reasonable protection against harmful interference in a residential installation.

This equipment generates, uses and can radiate radio frequency energy and, if not installed and used in accordance with the instructions, may cause harmful interference to radio communications.

However, there is no guarantee that interference will not occur in a particular installation. If this equipment does cause harmful interference to radio or television reception, which can be determined by turning the equipment off and on, the user is encouraged to try to correct the interference by one or more of the following measures:

1. Reorient or relocate the receiving antenna.
2. Increase the separation between the equipment and receiver.
3. Connect the equipment into an outlet on a circuit different from that to which the receiver is connected.
4. Consult the dealer or an experienced radio/TV technician for help.

WARNING: Make sure that the loudspeaker is securely installed in a stable position to avoid any injuries or damages to persons or properties. For safety reasons do not place one loudspeaker on top of another without proper fastening systems. Before hanging the loudspeaker check all the components for damages, deformations, missing or damaged parts that may compromise safety during installation. If you use the loudspeakers outdoor avoid spots exposed to bad weather conditions.

Contact dB Technologies for accessories to be used with speakers. dBTechnologies will not accept any responsibility for damages caused by inappropriate accessories or additional devices.

Features, specification and appearance of products are subject to change without notice.

dBTechnologies reserves the right to make changes or improvements in design or manufacturing without assuming any obligation to change or improve products previously manufactured.



SUB918

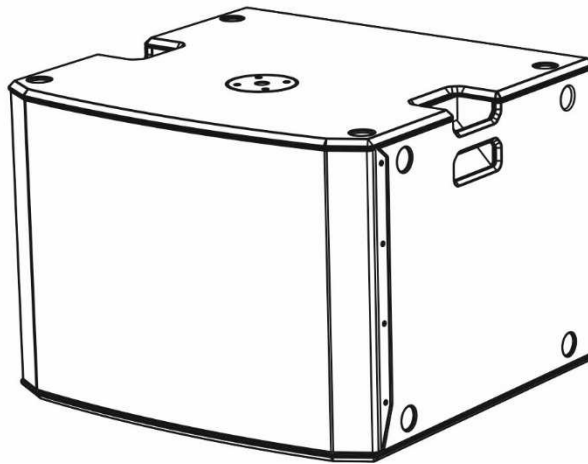

Quick start user manual *Section 1*

The warnings in this manual must be observed together with the "USER MANUAL - Section 2".

Le avvertenze nel presente manuale devono essere osservate congiuntamente al "MANUALE D'USO - Sezione 2".

Die Warnungen in diesem Handbuch müssen in Verbindung mit der "BEDIENUNGSANLEITUNG - Abschnitt 2" beobachtet werden".

Les avertissements spécifiés dans ce manuel doivent être respectés ainsi que les "CARACTERISTIQUES TECHNIQUES - Section 2"

Las advertencias del presente manual se deben tener en cuenta conjuntamente con las del "MANUAL DEL USUARIO" - Sección 2".

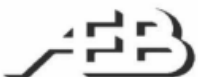

A.E.B. Industriale Srl Via Brodolini, 8 Località Crespellano 40053 VALSAMOGGIA BOLOGNA (ITALIA)
Tel +39 051 969870 Fax +39 051 969725 www.dbtechnologies.com info@dbtechnologies-aeb.com



Thank you for choosing a dBTechnologies Product!

Sub 918 is an active subwoofer, equipped with one 18" transducer (4" voice coil). It allows a deep configuration with different parameter controls (polarity, delay, xover/link frequency selection). It can be remote controlled, using Aurora Net software, thanks to the RDNNet section on the amplifier panel.

Check the site www.dbtechnologies.com for the complete user manual!

1) Unpacking

The box contains:

No. 1 SUB 918

No. 1 Mains cable with Neutrik® powerCON TRUE1 connector

No. 1 Fuse for 100-120V~ usage

This quick start and warranty documentation

2) Easy installation

The easy use in different configurations is guaranteed by:

A usage example is represented here following, for information only. Please refer to the accessories instructions and SUB 918 complete manual for further information.

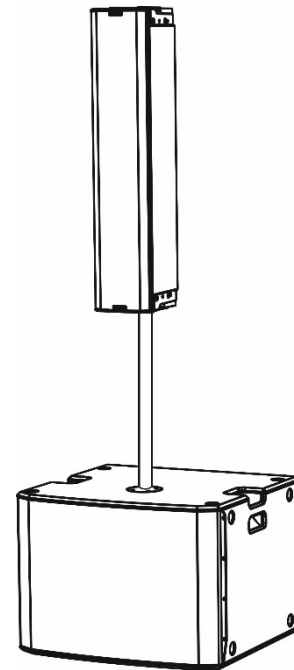
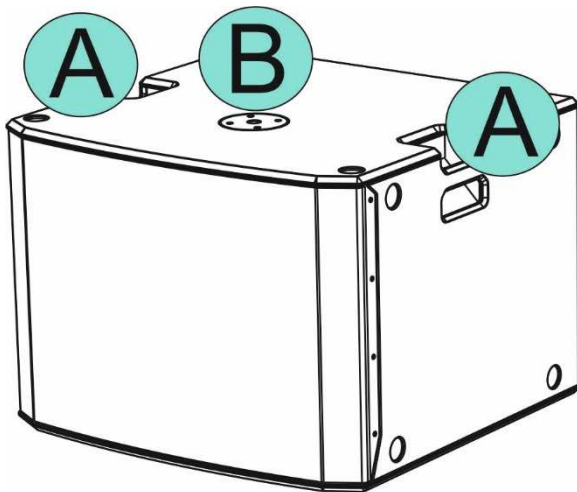

Example of use with IG4T on pole

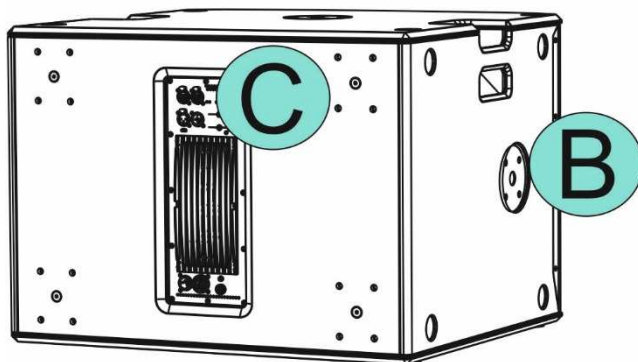

 *The product and accessories must be handled by trained personnel only! The user is required to follow regulations and mandatory laws on safety of the country in which the product is used. Don't use handles to suspend SUB 918!*

- handles [A]
- pole mount adapters [B]
- amplifier [C]

3) First switch on

The DIGIPRO G3 amplifier of SUB 918 is controlled by a powerful DSP. All the connections and controls are in the rear amplifier control panel:

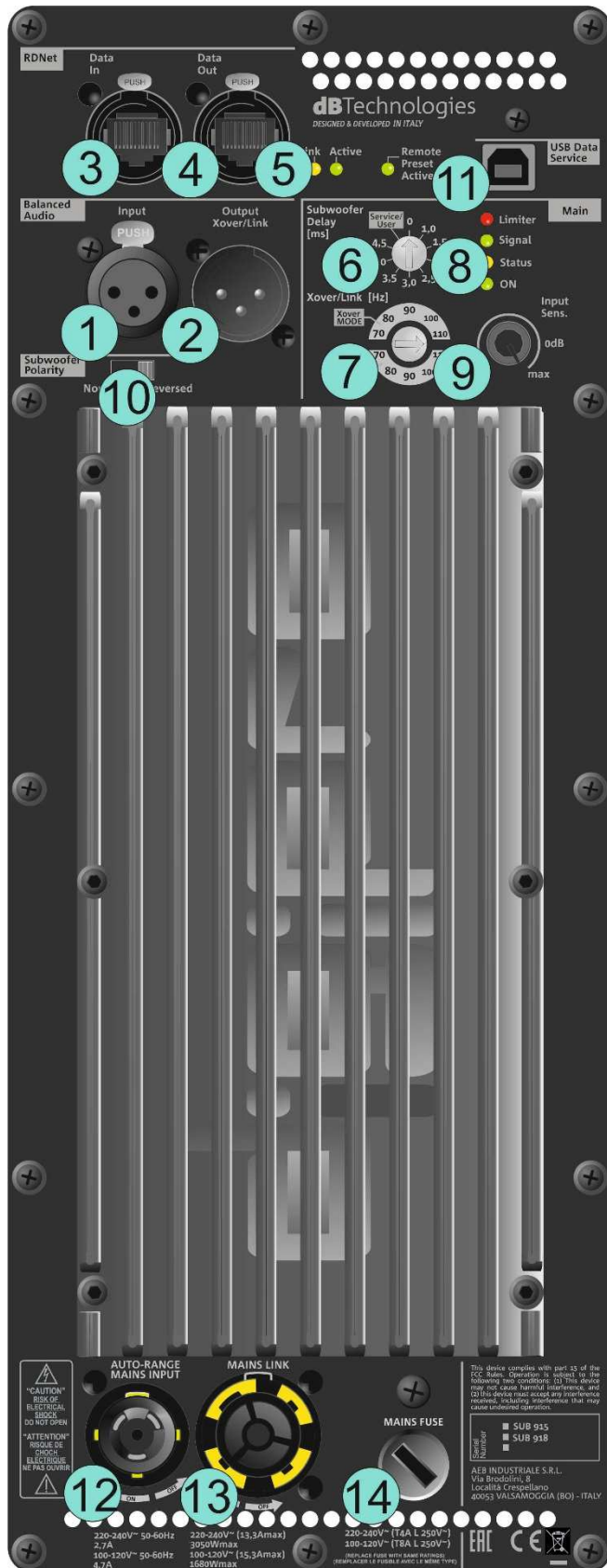

- 1 Input (balanced) connector
- 2 Output Xover/Link (balanced) connector
- 3 RDNet Data In
- 4 RDNet Data Out
- 5 RDNet status LEDs
- 6 Subwoofer delay [ms] rotary
- 7 Xover/Link frequency selector
- 8 General Status LEDs
- 9 Input sensitivity
- 10 Subwoofer polarity
- 11 Usb data service
- 12 Mains Input (Auto-range)
- 13 Mains Link
- 14 Mains Fuse

The subwoofer is supplied with one mounted fuse for operation within the 220-240V~ range. If you need to operate in the 100-120V~ voltage range:

- **Disconnect all connections, including the power supply**
- **Wait 5 minutes**
- **Replace the fuses with the ones provided in the package for the 100-120V~ range**

a) Once you have properly set up the desired configuration (see also the SUB 918 complete user manual and accessories instructions for further information), connect the audio input (1). Set the Subwoofer polarity (10) and Input Sensitivity (9) to the desired level.

b) Connect the possible Xover/Link output (2) and adjust the related frequency (7).

c) Adjust the subwoofer delay (6)

d) In case of remote control, connect the Data Input (3) to the hardware remote controller (RDNet Control 2 or RDNet Control 8) with cables equipped with etherCON connectors. Then connect the Data Output (4) to the Data Input (3) of a possible second device, and so on. When the RDNet network is on and it has recognized the connected device, the LED "Link" (5) is on. The other LEDs (5) "Active" start blinking at the presence of data transmission, the "Remote Preset Active" advise that all the local controls set on the amplifier panel (level, DSP presets, etc.) are by-passed and controlled remotely by RDNet.

In remote control it is essential the use of free dBTechnologies software:

- **dBTechnologies AURORA NET**, necessary for an in-depth real-time control of different devices;

e) Connect the power supply (12). It is possible to link other sub 918 using mains link connector (13) (see Technical Data for further information).

Check the complete user manual on www.dbtechnologies.com for further information about the system and available accessories.

Scarica il manuale completo da www.dbtechnologies.com per ogni ulteriore informazione sul sistema e sugli accessori disponibili.

Für weitere Informationen und verfügbares Zubehör lesen sie bitte die vollständige Bedienungsanleitung unter www.dbtechnologies.de.

Vérifiez le manuel de l'utilisateur complet sur www.dbtechnologies.com pour des informations complémentaires du système et des accessoires disponibles. Compruebe el manual de usuario completo sobre www.dbtechnologies.com para la información adicional sobre el sistema y accesorios disponibles.