

# ALLEN & HEATH



## USER GUIDE

Publication AP7028



## **Limited One Year Warranty**

This product is warranted to be free from defects in materials or workmanship for period of one year from the date of purchase by the original owner.

To ensure a high level of performance and reliability for which this equipment has been designed and manufactured, read this User Guide before operating. In the event of a failure, notify and return the defective unit to ALLEN & HEATH Limited or its authorised agent as soon as possible for repair under warranty subject to the following conditions

### **Conditions Of Warranty**

The equipment has been installed and operated in accordance with the instructions in this User Guide.

The equipment has not been subject to misuse either intended or accidental, neglect, or alteration other than as described in the User Guide or Service Manual, or approved by ALLEN & HEATH.

Any necessary adjustment, alteration or repair has been carried out by ALLEN & HEATH or its authorised agent.

This warranty does not cover fader wear and tear.

The defective unit is to be returned carriage prepaid to ALLEN & HEATH or its authorised agent with proof of purchase.

Units returned should be packed to avoid transit damage.

In certain territories the terms may vary. Check with your ALLEN & HEATH agent for any additional warranty which may apply.

This product complies with the European Electro magnetic Compatibility directives 89/336/EEC & 92/31/EEC and the European Low Voltage Directives 73/23/EEC & 93/68/EEC.

This product has been tested to EN55103 Parts 1 & 2 1996 for use in Environments E1, E2, E3, and E4 to demonstrate compliance with the protection requirements in the European EMC directive 89/336/EEC. During some tests the specified performance figures of the product were affected. This is considered permissible and the product has been passed as acceptable for its intended use. Allen & Heath has a strict policy of ensuring all products are tested to the latest safety and EMC standards. Customers requiring more information about EMC and safety issues can contact Allen & Heath.

ZED 4 BUS User Guide AP7028 Issue 1

Copyright © 2007 Allen & Heath Limited. All rights reserved

Allen & Heath Limited

Kernick Industrial Estate, Penryn, Cornwall, TR10 9LU, UK

<http://www.allen-heath.com>

# PACKED ITEMS

Check that you have received the following:

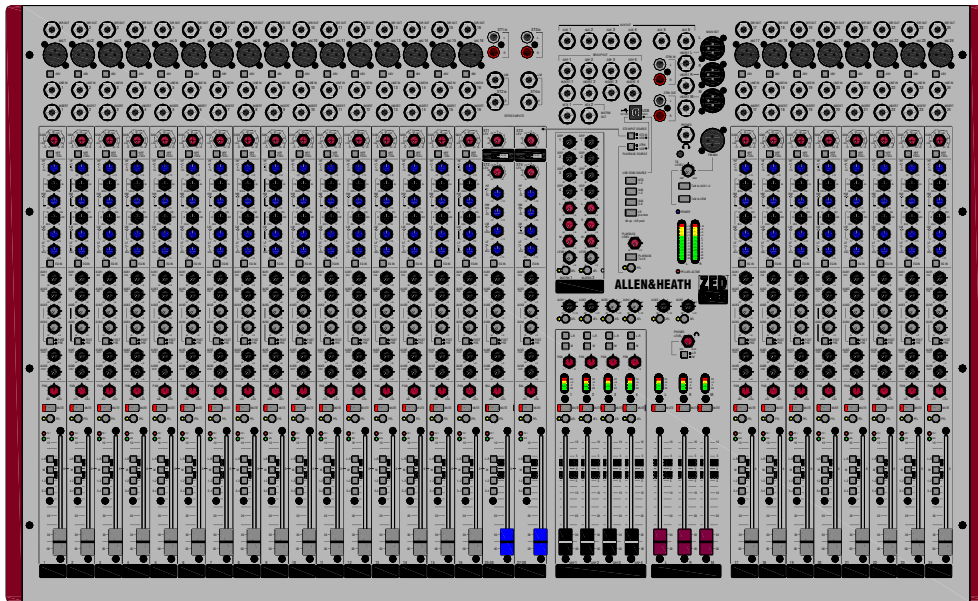

ZED-420, ZED428 or ZED-436 MIXER

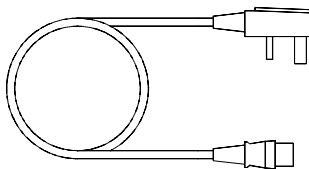

Mains Lead

Check that the correct mains plug is fitted.

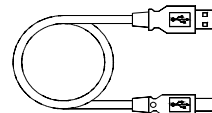

Type A-B USB Lead

To connect the ZED to your computer.

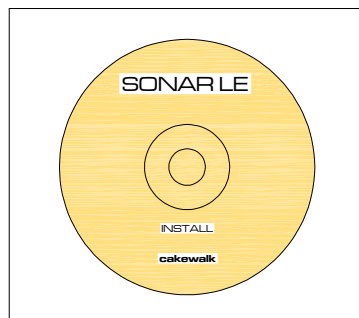

SONAR LE  
Music Software Install disk.

# SAFETY INSTRUCTIONS

**WARNINGS - Read the following before proceeding :**

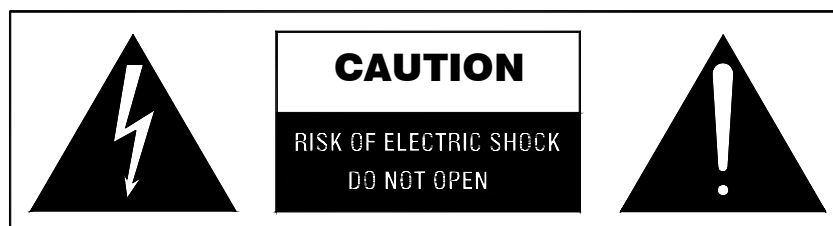

**ATTENTION: RISQUE DE CHOC ELECTRIQUE – NE PAS OUVRIR**

**Read instructions:** Retain these safety and operating instructions for future reference. Adhere to all warnings printed here and on the console. Follow the operating instructions printed in this User Guide.

**Do not remove cover:** Operate the console with its covers correctly fitted.

**Power sources:** Connect the console to a mains power unit only of the type described in this User Guide and marked on the rear panel. Use the power cord with sealed mains plug appropriate for your local mains supply as provided with the console. If the provided plug does not fit into your outlet consult your service agent for assistance.

**Power cord routing:** Route the power cord so that it is not likely to be walked on, stretched or pinched by items placed upon or against it.

**Grounding:** Do not defeat the grounding and polarisation means of the power cord plug. Do not remove or tamper with the ground connection in the power cord.



**WARNING: This equipment must be earthed.**

**Water and moisture:** To reduce the risk of fire or electric shock do not expose the console to rain or moisture or use it in damp or wet conditions. Do not place containers of liquids on it which might spill into any openings.

**Ventilation:** Do not obstruct the ventilation slots or position the console where the air flow required for ventilation is impeded. If the console is to be operated in a rack unit or flightcase ensure that it is constructed to allow adequate ventilation.

**Heat and vibration:** Do not locate the console in a place subject to excessive heat or direct sunlight as this could be a fire hazard. Locate the console away from any equipment which produces heat or causes excessive vibration.

**Servicing:** Switch off the equipment and unplug the power cord immediately if it is exposed to moisture, spilled liquid, objects fallen into the openings, the power cord or plug become damaged, during lightening storms, or if smoke, odour or noise is noticed. Refer servicing to qualified technical personnel only.

**Installation:** Install the console in accordance with the instructions printed in this User Guide. Do not connect the output of power amplifiers directly to the console. Use audio connectors and plugs only for their intended purpose.

# SAFETY INSTRUCTIONS

## Important Mains plug wiring instructions

The console is supplied with a moulded mains plug fitted to the AC mains power lead. Follow the instructions below if the mains plug has to be replaced. The wires in the mains lead are coloured in accordance with the following code:



TERMINAL		WIRE COLOUR	
		European	USA/Canada
L	LIVE	BROWN	BLACK
N	NEUTRAL	BLUE	WHITE
E	EARTH GND	GREEN & YELLOW	GREEN

The wire which is coloured Green and Yellow must be connected to the terminal in the plug which is marked with the letter E or with the Earth symbol. This appliance must be earthed.

The wire which is coloured Blue must be connected to the terminal in the plug which is marked with the letter N.

The wire which is coloured Brown must be connected to the terminal in the plug which is marked with the letter L.

Ensure that these colour codes are followed carefully in the event of the plug being changed.

## General Precautions:

**Damage :** To prevent damage to the controls and cosmetics avoid placing heavy objects on the control surface, scratching the surface with sharp objects, or rough handling and vibration.

**Environment :** Protect from excessive dirt, dust, heat and vibration when operating and storing. Avoid tobacco ash, smoke, drinks spillage, and exposure to rain and moisture. If the console becomes wet, switch off and remove mains power immediately. Allow to dry out thoroughly before using again.

**Cleaning :** Avoid the use of chemicals, abrasives or solvents. The control panel is best cleaned with a soft brush and dry lint-free cloth. The faders, switches and potentiometers are lubricated for life. The use of electrical lubricants on these parts is not recommended. The fader and potentiometer knobs may be removed for cleaning with a warm soapy solution. Rinse and allow to dry fully before refitting them.

**Transporting :** The console may be transported as a free-standing unit or mounted in a rack or flightcase. Protect the controls from damage during transit. Use adequate packing if you need to ship the unit.

**Hearing :** To avoid damage to your hearing do not operate any sound system at excessively high volume. This applies particularly to close-to-ear monitoring such as headphones and in-ear systems. Continued exposure to high volume sound can cause frequency selective or wide range hearing loss.



# CONTENTS

Thank you for purchasing your Allen & Heath ZED mixer. To ensure that you get the maximum benefit from the unit please spare a few minutes familiarizing yourself with the controls and setup procedures outlined in this user guide. For further information please refer to the additional information available on our web site, or contact our technical support team.

<http://www.allen-heath.com>

<http://www.allen-heath.com/zed>

<http://www.myspace.com/thezedspace>

Warranty .....	3
Packed Items.....	4
Safety Instructions .....	5
Contents.....	7
Panel Drawings.....	8
Introduction to ZED .....	11
Specifications .....	12
Dimensions .....	13
Block Diagram.....	14
Mono Input Channel .....	15
Stereo Input Channel.....	19
Matrix Outputs & Aux Masters.....	22
Group Masters .....	23
L R & M Masters & Headphones ....	24
Main Meters and Talkback .....	25
USB Selection and Playback.....	26
USB Connection .....	27
SONAR LE software introduction .	28
SONAR LE installation .....	29
Configuring SONAR LE with ZED.	29
Using USB for effects .....	32
Wiring Notes .....	33
Product Support .....	34

# PANEL DRAWINGS—ZED420

**CAUTION**  
RISK OF ELECTRICAL SHOCK  
DO NOT OPEN THE FRONT PANEL  
RISK OF ELECTRIC SHOCK TO THE USER  
RISK OF ELECTRIC SHOCK TO THE USER  
RISK OF ELECTRIC SHOCK TO THE USER

**ALLEN & HEATH ZED 420**

**ALLEN & HEATH ZED 420**





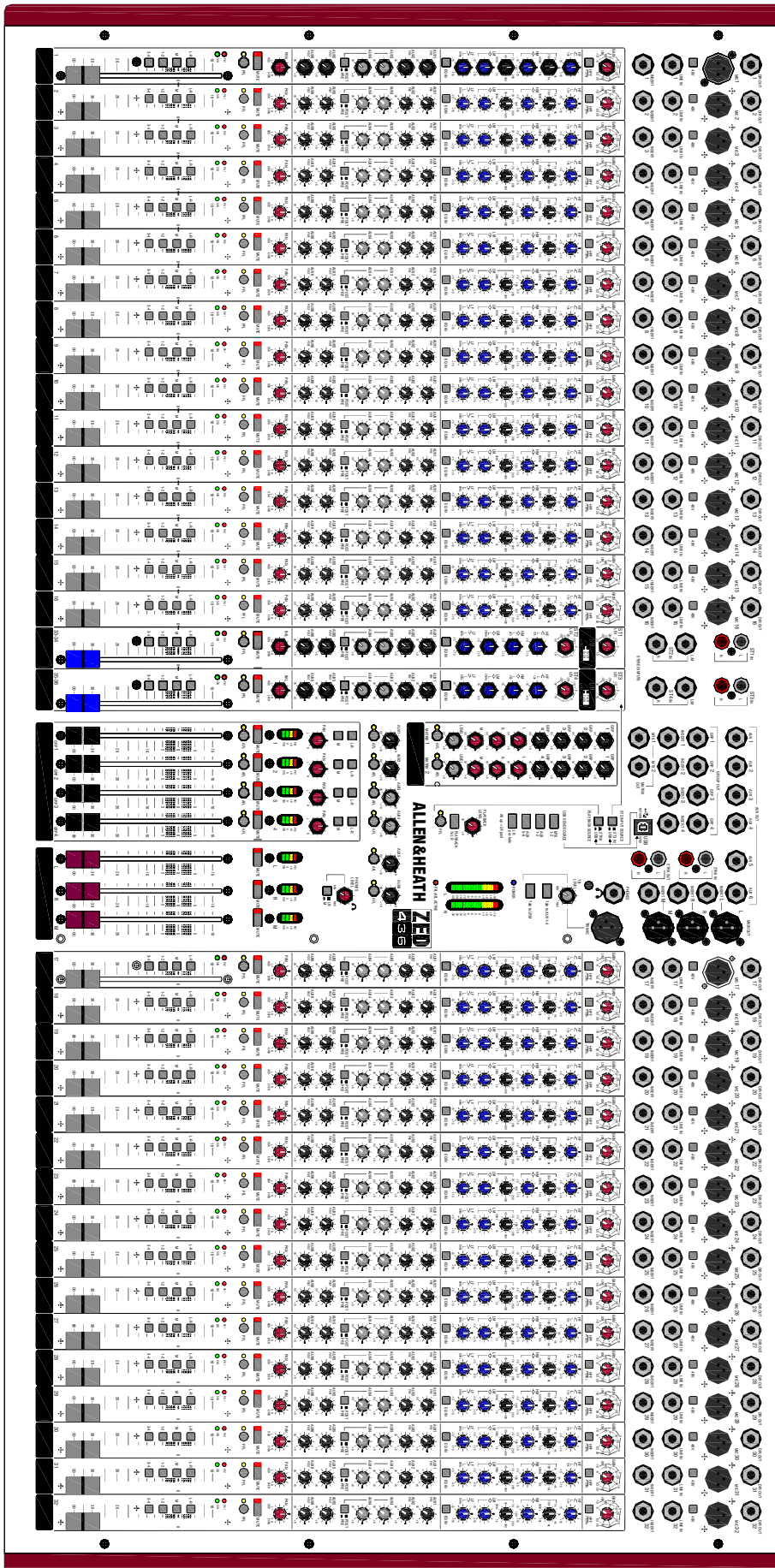

# PANEL DRAWINGS—ZED436

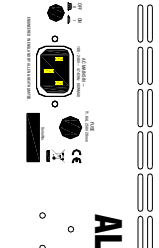

  
**ALLEN&HEATH**
  
**ZED**
  
**436**

# INTRODUCTION TO THE ZED-4 BUS MIXERS

## A Technical Overview:

The Allen & Heath ZED-4 mixer has been carefully and lovingly designed in the beautiful county of Cornwall in the UK and is manufactured alongside a wide range of professional audio mixing consoles. Many of the components used in ZED are exactly the same as in the larger Allen & Heath products and the construction methods are also very similar — utilising individual vertically mounted channel circuit boards with each rotary control fixed with a metal nut to the front panel. This provides a very robust product that will resist damage and give years of reliable use. It also makes servicing much easier should it be required, with the ability to remove one particular channel from the mixer at a time, or easily change a fader.

The audio circuitry is based on years of continual development and refinement, the performance of all the elements within the mixer scrutinised and perfected to ensure the very best sound quality possible.

## Mic/Line Pre-amps:

Based on the pre-amps from the PA series, the ZED series pre-amps use a two stage design, with carefully controlled amounts of gain in each stage. When amplifying the signal from the XLR input, the gain range is huge — 69dB of range to be exact — and is very evenly distributed around the gain control, meaning better control of signal level. Most of the gain comes from the first stage, so unwanted noise is kept to a minimum. There is no “pad” switch, or pad circuit — line level signals are simply plugged into the second stage of the pre-amp by using the line input jack socket. This has the great advantage of lower noise when using the line input. (It is common to attenuate line level signals, then amplify them back up again which can give more noise or hiss).

## EQ:

The ZED-4 series mixers are equipped with a 4-band equaliser circuit on each input, based closely on the acclaimed GL2400 EQ. The frequency and response of each has been carefully chosen to give the maximum performance when using the EQ on a variety of sources.

## AUX system:

Six auxiliary sends are provided, two pre-fade, two post fade, and two switched pre or post fade. The Aux master level controls are grouped nicely together in the master section and have AFL (after fade listen) switches for monitoring.

## Groups:

The four sub-groups can be used for easy control of groups of inputs, or for applying signal processing such as compression to groups of signals using the Group Insert connector. The groups have individual outputs and can also be sub-mixed to the main L-R and Mono mixes.

## Main Mix:

In addition to the main L-R stereo bus, there is a Mono bus which can be routed to individually, ideal for feeding low frequency speaker systems, or creating a mono PA mix.

## Mono and Stereo Channels:

The ZED-420, 428 and 436 models have a full complement of 16, 24 and 32 mono inputs respectively, plus two stereo channels, maximising the number of inputs you get. The Stereo channels are dual, so you can get 4 stereo inputs to mix before you need to use any mono channels.

## USB:

Getting audio to and from a computer easily is now a common requirement for live sound and music production. The way we have implemented this on ZED is super-flexible and super-easy! No longer do you need to fiddle around the back of your PC to get to the soundcard inputs, only to find that the levels are all wrong and noisy. Just plug in a USB lead to your ZED, select the USB routing on the mixer and the device on your computer and that's it! Quality audio to and from your PC or MAC.

**As you can tell, we're very proud of this product we hope you like it too!**

# SPECIFICATIONS

## Operating Levels

<b>Inputs</b>	
Mono channel (XLR) Input	+6 to -63dBu for nominal (+17dBu in max)
Mono channel Line Input (Jack socket)	+10 to -26dBu (+30dBu maximum)
Insert point (TRS Jack socket)	0dBu nominal +21dBu maximum
Stereo Input (Jack sockets)	0dBu nominal (control = Off to +10dB)
Stereo input (phono sockets)	0dBu nominal (control = Off to +10dB)
2 Track Input (phono sockets)	0dBu nominal +21dBu maximum
<b>Outputs</b>	
L, R & Mono Outputs (XLR)	+4dBu nominal. +27dBu maximum.
L, R & M Insert (TRS Jack socket)	-2dBu nominal +21dBu maximum
Group Outputs (Jack sockets)	+4dBu nominal. +27dBu maximum.
Group Insert (TRS Jack socket)	-2dBu nominal +21dBu maximum
Aux Outputs (Jack sockets)	-2dBu nominal +21dBu maximum (Bal Option +4)
Matrix Outputs (TRS Jack socket)	-2dBu nominal. +21dBu maximum. (Bal Option +4)
2 Track Output (phono sockets)	0dBu nominal. +21dBu maximum.
Direct Out (TRS Jack socket)	0dBu nominal. +21dBu maximum.

## Headroom

Analogue Headroom from nominal (0Vu)	21 dB
USB in & out headroom from nominal (0Vu)	14dB

## Frequency Response

Mic in to Mix L/R Out, 30dB gain	+0.5/-1dB 20Hz to 20kHz.
Line in to Mix L/R out 0dB gain	+0.5/-1dB 10Hz to 30kHz
Stereo in to Mix L/R out	+0.5/-1dB 10Hz to 30kHz

## THD+n

Mic in to Mix L/R Out, 0dB gain 1kHz +10dBu out	0.004%
Mic in to Mix L/R Out, 30dB gain 1kHz	0.014%
Line in to Mix L/R out 0dB gain 0dBu 1kHz	0.005%
Stereo in to Mix L/R out 0dB gain +10dBu 1kHz	0.003%

## USB Audio CODEC (Coder/Decoder)

USB Audio In/Out	USB 1.1 compliant 16bit.
Sample Rate	32, 44.1, or 48kHz

## Noise

Mix Noise, LR out, 16 channels routed, Ref +4dBu, 22-22kHz	-90dB (-86dBu)
Mix Noise, LR out, 24 channels routed, Ref +4dBu, 22-22kHz	-89dB (-85dBu)
Mix Noise, LR out, 32 channels routed, Ref +4dBu, 22-22kHz	-88dB (-84dBu)
Mic Pre EIN @ max gain 150R input Z 22-22kHz	-127dBu

# Dimensions

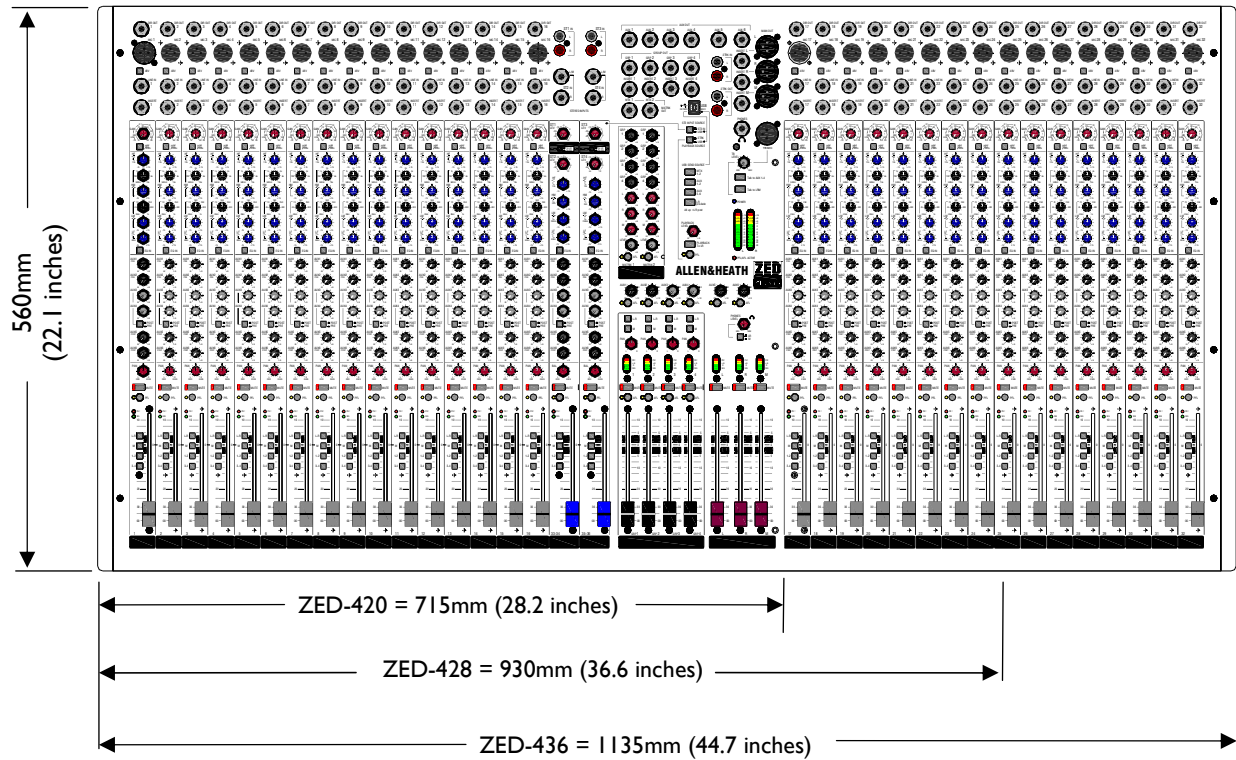
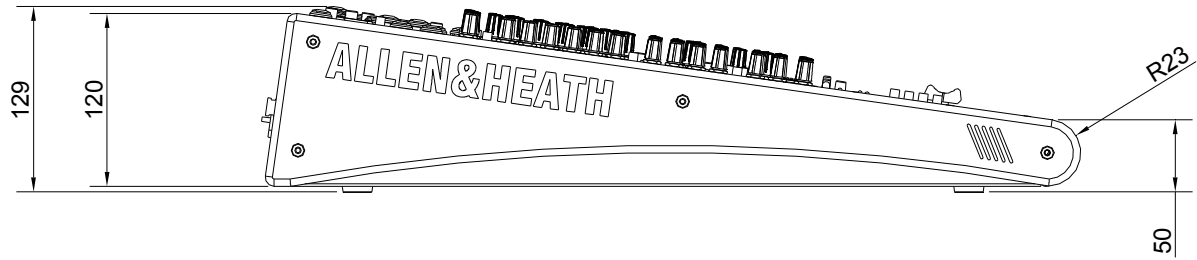

Weight kg (lb)		
Model	Unpacked	Packed
ZED-420	14 (31 lb)	17.5 (38.5 lb)
ZED-428	18 (40 lb)	22.5 (56.25 lb)
ZED-436	22 (48.5 lb)	26.5 (58.3 lb)

# BLOCK DIAGRAM

## ZED-4 BLOCK DIAGRAM

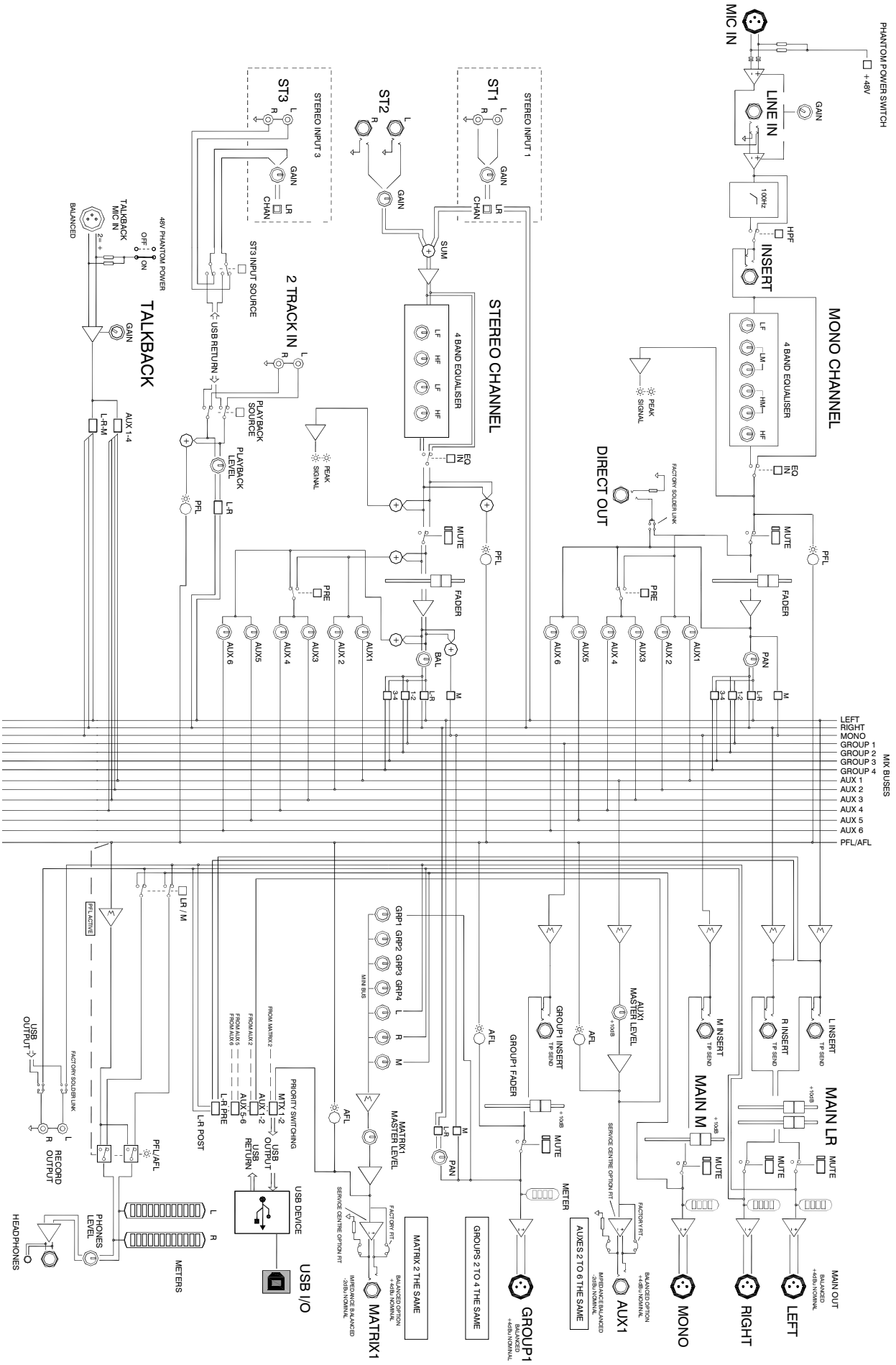

# MONO INPUT CHANNEL

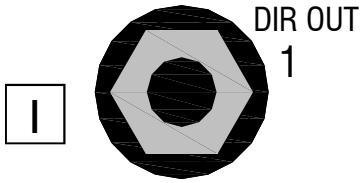

**1 Direct Output Socket**  
Standard 1/4" (6.25mm) Jack socket. Wired Tip=Hot(+), Ring=cold (-), Sleeve=Chassis. For recording individual channels, factory default is prefade signal (post mute). The nominal level is 0dBu and the output is impedance balanced.

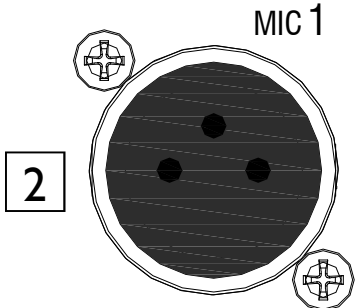

**2 Microphone Input Socket**  
Standard 3-Pin XLR socket wired as Pin 1=Chassis, Pin 2=hot (+), Pin 3=Cold (-).



**3 48V Phantom Power Switch**  
Applies +48V to pins 2 and 3 of the XLR input through 6k8 resistors for phantom powered condenser microphones.

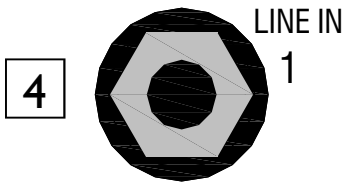

**4 Line Input Jack Socket**  
Standard 1/4" (6.25mm) Jack socket for balanced or unbalanced line level signals. Wired Tip=Hot(+), Ring=cold (-), Sleeve=Chassis. The Line input overrides the Mic input, so if you want to hear something plugged in to the xlr socket, make sure nothing is plugged into the Line input.

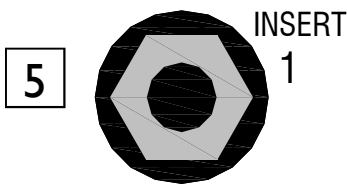

**5 Insert Jack Socket**  
Standard 1/4" (6.25mm) Jack socket for unbalanced insert send and return signals. Wired Tip=send, Ring=return, Sleeve=Chassis. Nominal level is 0dBu. The insert point is after the 100Hz filter and before the EQ.

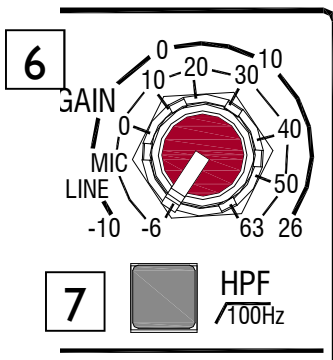

**6 Gain Control**  
This adjusts the gain of the input amplifier to match the signal level of the input. The gain is varied from -6dB (attenuation) to +63dB for signals plugged in to the xlr socket (Mic Input) and -10dB to +26dB for signals plugged into the Line input jack.

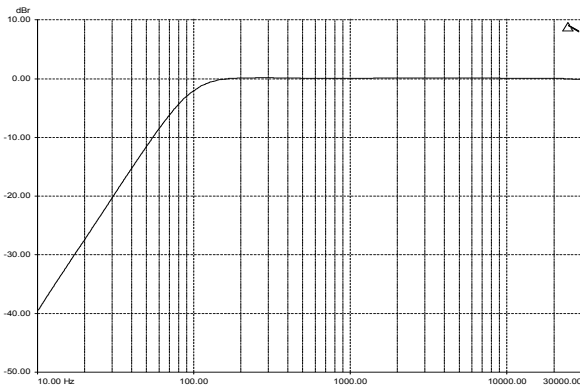

**7 100Hz Hi-pass Filter**  
The Hi-pass filter is used for reducing pop noise and rumble from microphone signals. It is a 2-pole (12dB per octave) filter with a corner frequency set at 100Hz. The filter affects signals from both Mic XLR and Line jack socket.

# MONO INPUT CHANNEL

6

HF

7

HM

8

LM

LF

EQ IN

**6 HF EQ**  
 The HF (High Frequency) equaliser affects the frequency response of the higher audible frequencies. The corner frequency of 12kHz is around 3dB from the maximum cut or boost of the circuit.

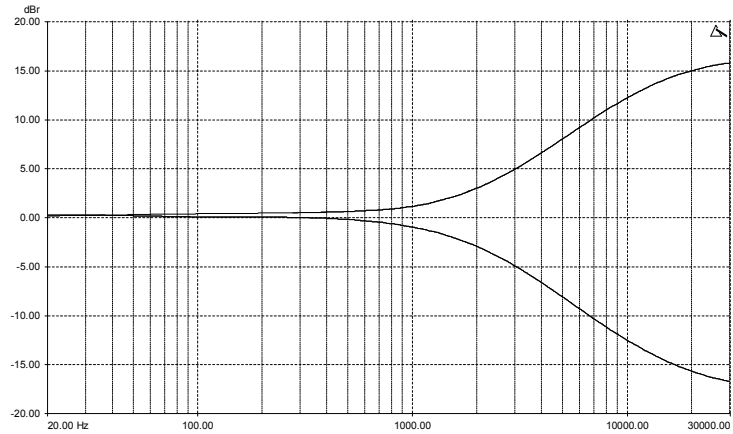

**7 HMF EQ**  
 The HMF (High Mid Frequency) equaliser affects the upper middle of the audible frequency range. The frequency graduations on the sweep control are the centre frequencies of the EQ.

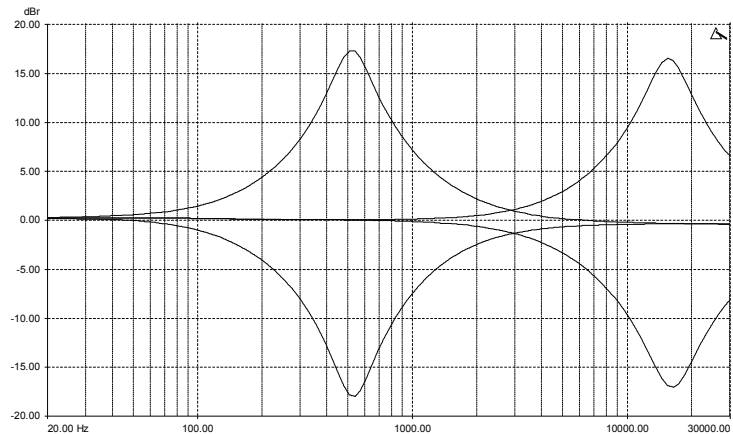

**8 LMF EQ**  
 The LMF (Lower Mid Frequency) equaliser affects the lower middle of the audible frequency range.

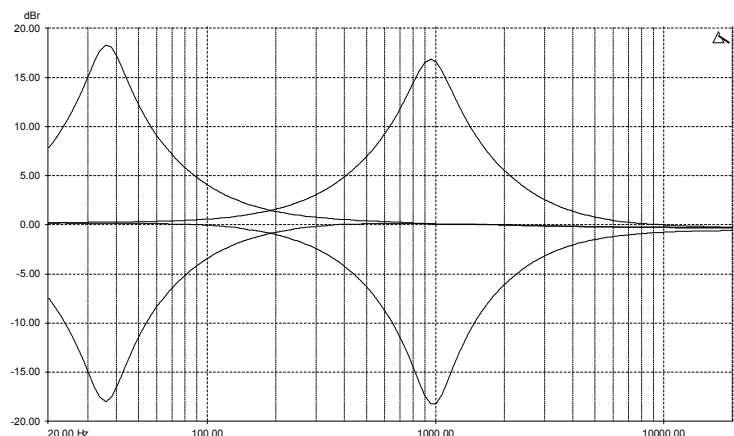



# MONO INPUT CHANNEL

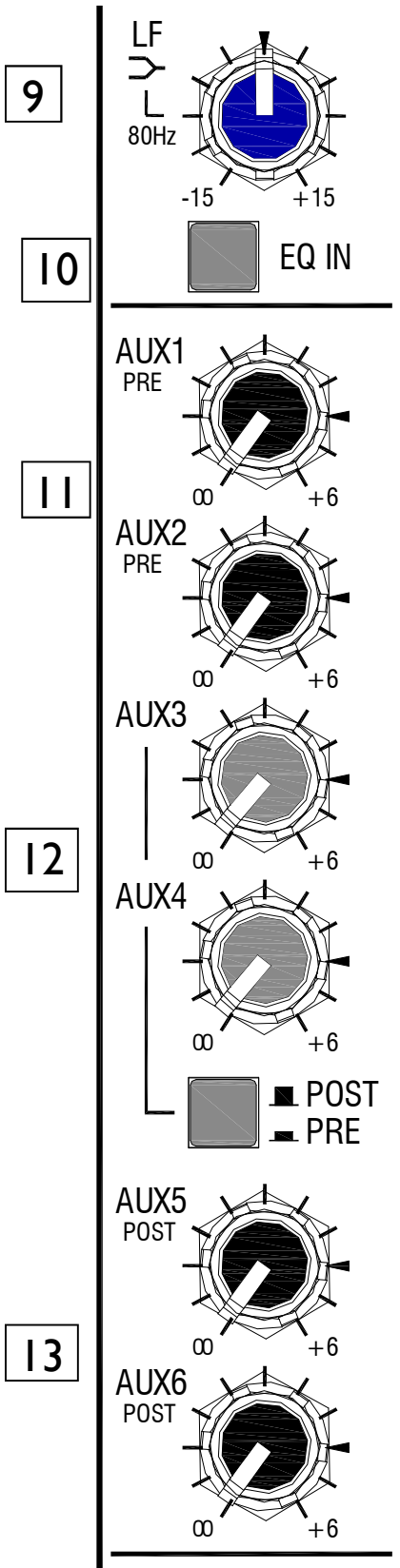

**9 LF EQ**  
The LF (Low Frequency) equaliser affects the response at the low end of the audio range. The graph shows the response of the LF EQ at maximum cut and boost. The corner frequency is 80Hz.

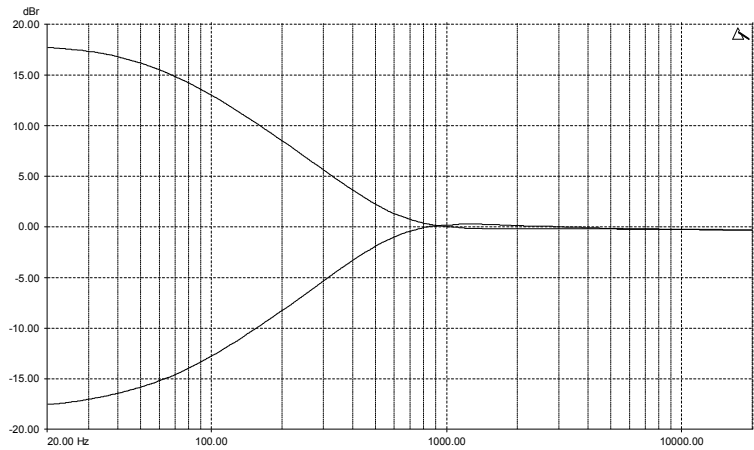

**10 EQ IN**  
The EQ IN switch enables the equaliser when pushed in. The EQ is bypassed when the switch is in its up position.

**11 Auxes 1 & 2**  
Each of these controls sends a signal to an auxiliary bus. The signal is sourced pre-fade which means that the level is independent of, and unaffected by the fader. Auxes 1 & 2 are primarily used for foldback monitoring purposes, as the fader does not affect the level. They can also be used as feeds for recording and are available sources to the USB interface for this purpose. These sends are affected by the Mute switch, so muting the channel will also mute the Aux sends. The control varies the signal level to the bus from off (fully attenuated) to +6dB, with unity gain at the arrow. There are master level controls for all of the Aux outputs situated in the master section of the mixer.

**12 Auxes 3 & 4**  
These are switched pre or post-fade so they can be used as either monitor sends or effects sends.

**13 Auxes 5 & 6**  
Sourced post fade, so that the level is set with the send control but will be affected by the fader position. Mainly used for effects.

# MONO INPUT CHANNEL

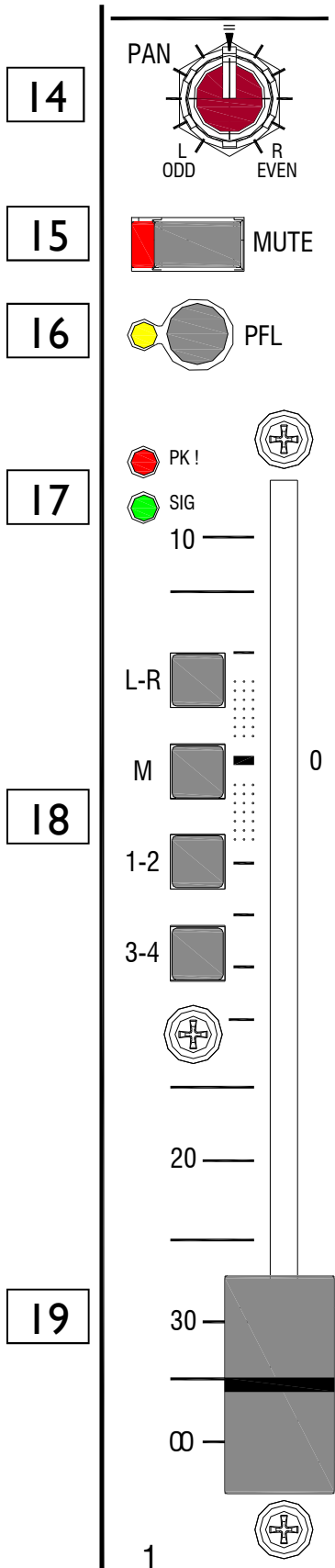

**14 PAN**  
The pan control adjusts how the signal from the mono input channel is shared between the left and right buses and subsequently the main stereo outputs, similarly to pairs of Groups. Set to the mid position, equal amounts of signal are fed to left and right, with pan set to L, none is sent to the Right bus.

**15 Mute Switch**  
This mutes or cuts the signal to the buses and the Direct Out. A rectangular LED illuminates to show the Mute switch is pressed.

**16 PFL Switch**  
The PFL (Pre-Fade Listen) switch sends the channel signal to the PFL bus and subsequently to the headphones and the main L R meters. Used for checking the audio signal before raising the fader or un-muting the channel.

**17 Signal & PK! LED**  
The Signal LED illuminates dimly at a threshold of  $-16\text{dB}$  nominal level and gets brighter with higher level signal. The source for the signal & peak LED's is just after the EQ IN switch.

The PK! LED illuminates when the signal just after the EQ IN switch is within 5dB of clipping.

**18 Routing Switches**  
The routing switches connect the post-fade signal to the mix buses via the pan control for the main LR bus and the group buses. For minimum noise from the mix bus summing amplifier, leave the switches in their up positions if the channel signal is not required on the bus.

**19 Fader**  
The 100mm fader affects the level of the channel signal to the left & right, mono and group buses and Auxes 5 & 6. Also Auxes 3 & 4 if switched to post-fade. There is 10dB of gain at the top and the unity gain position is marked by "0".

# STEREO INPUT CHANNEL

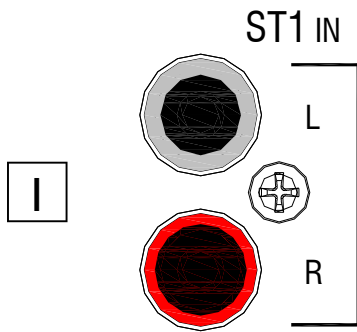

## 1 ST1 (& ST3) Phono sockets

These are stereo inputs additional to the main stereo channel inputs (below). The gain is varied by the ST1 (& ST3) level control and these inputs can be sent to either the stereo channels or straight to the L R main bus, depending on the setting of the under-panel switch. These inputs are unbalanced.

The source for the ST3 input can be switched from the phono sockets to the USB return signal with the selector switch below the USB socket.

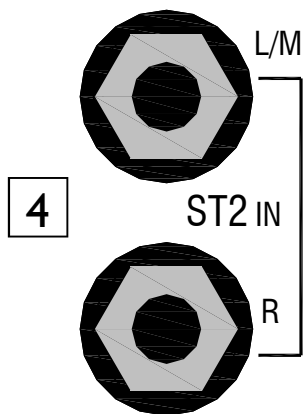

## 2 Stereo Inputs 1 (& 3) Level control

Adjust the level of the stereo inputs 1 & 3 from off (fully attenuated) to maximum where it has 10dB of gain.

## 3 ST1 (& 3) Routing selector switch

This switch selects whether the ST1 (or ST3) signal is sent to the L R bus directly, or the stereo channel below. When it is pressed in, the ST1 (or ST3) signal sums together with the main stereo inputs ST2 (or ST4).

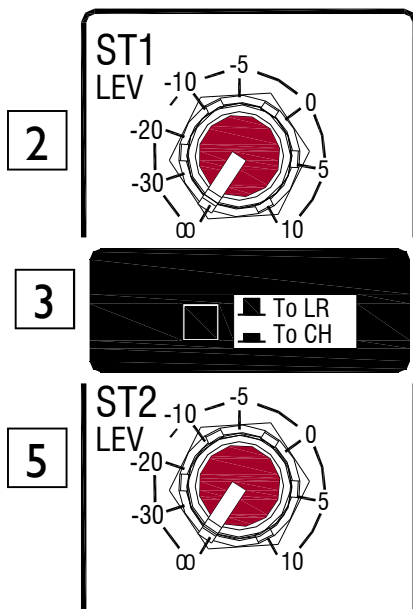

## 4 ST2 (& ST4) input jack sockets

Standard 1/4" jack sockets for line level stereo signals. Can be used with a mono input where the L/M input will also connect to the R input if nothing is plugged in to R.

The Stereo 1 inputs accept unbalanced or balanced signals.

## 5 Stereo Input ST2 (& ST4) Level control

Adjusts the level of the ST2 (& ST4) input. The range is from off to +10dB.

# STEREO INPUT CHANNEL

6

## STEREO Channel EQ

The EQ on the stereo Channel is 4 band, fixed frequency and comprises a shelving high frequency section, a shelving low frequency section and two fixed mid frequency controls.

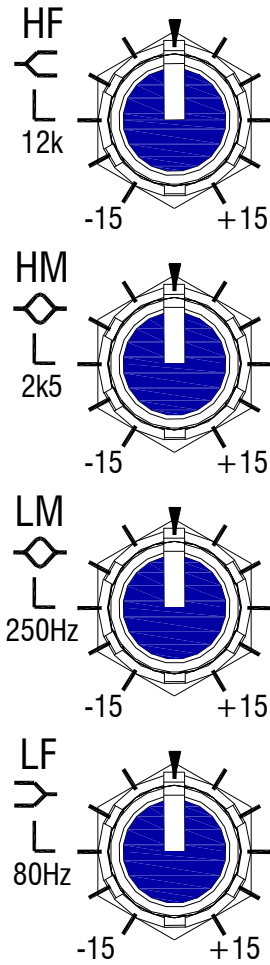

6

### STEREO HF EQ

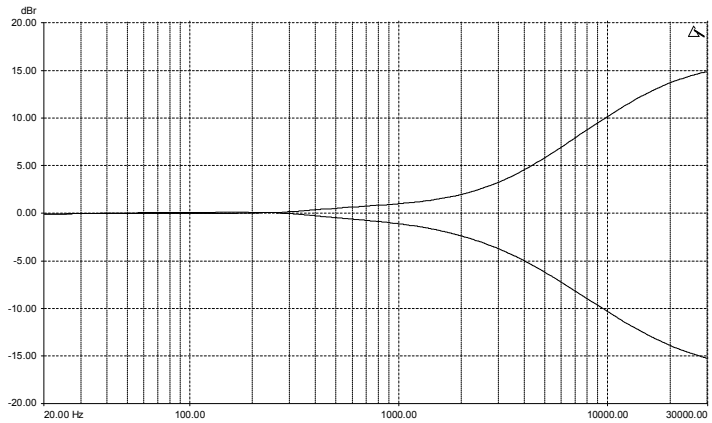

### STEREO LF EQ

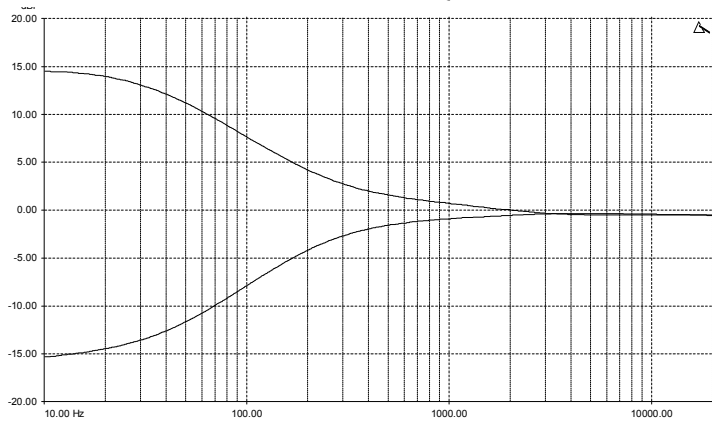

7



EQ IN

7

## EQ IN

The EQ IN switch enables the equaliser when pushed in. The EQ is bypassed when the switch is in its up position.

### STEREO LMF AND HMF EQ

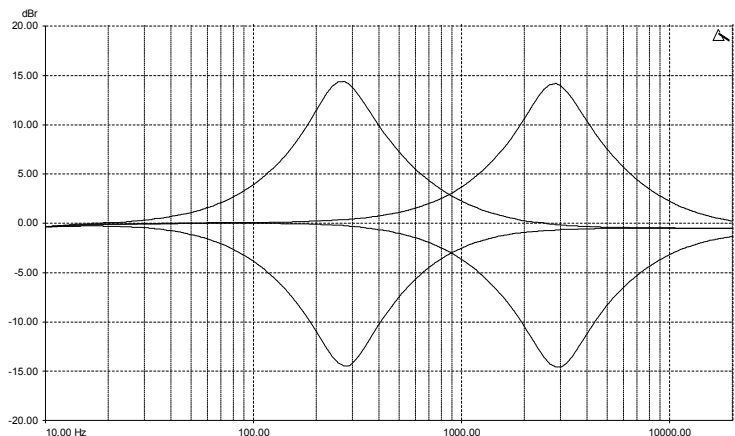

# STEREO INPUT CHANNEL

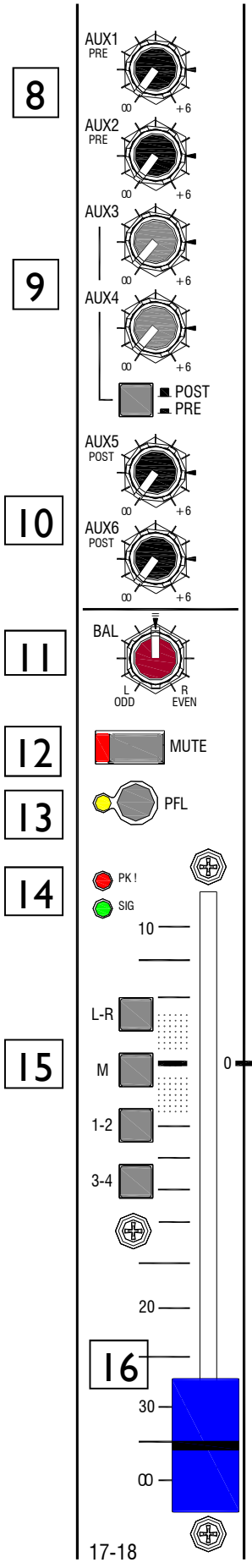

**8 Auxes 1 & 2**  
 Auxes 1 & 2 send a mono sum of the stereo channel left & right signals sourced from pre-fader.

**9 Auxes 3 & 4**  
 Again, a mono sum of the stereo channel left & right signals, the source being switchable pre or post fader.

**10 Auxes 5 & 6**  
 Auxes 5 & 6 take their source from a mono sum of the stereo channel left & right signals after the fader.

**11 Balance control**  
 The Balance control varies the relative levels between the left and right channels.

**12 Mute Switch**  
 Mutes the signals to the main L R, M and Group buses as well as the Aux sends.

**13 PFL Switch**  
 The PFL (Pre-Fade Listen) switch sends a mono sum of the stereo channel signal to the PFL bus.

**14 Signal & PK! LED**  
 The Signal LED illuminates dimly at a threshold of -16dB on either left or right channels and gets brighter with higher level signal. The source for the signal & peak LED's is just after the EQ IN switch.

The PK! LED illuminates when the signal just after the EQ IN switch is within 5dB of clipping.

**15 Routing Switches**  
 The routing switches connect the post-fade signal to the mix buses via the balance control for L\_R and the groups. For minimum noise from the mix bus summing amplifier, leave the switches in their up positions if the channel signal is not required on the bus.

**16 Fader**  
 The 100mm fader affects the level of the channel signal to the left & right, mono and group buses and Auxes 5 & 6. Also Auxes 3 & 4 if switched to post-fade. There is 10dB of gain at the top and the unity gain position is marked by "0".

# MATRIX OUTPUTS & AUX MASTERS

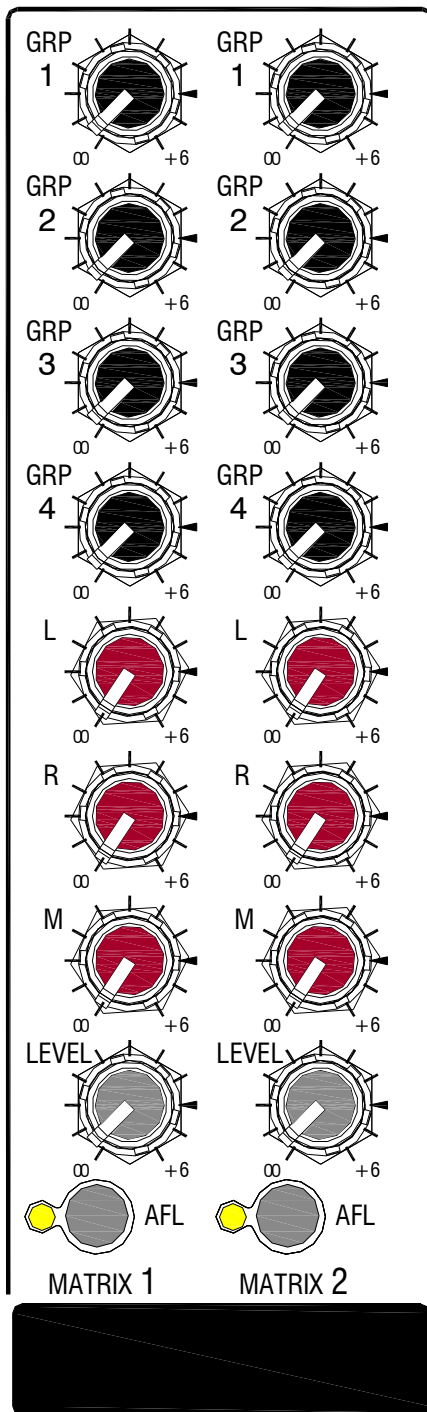

## Matrix Outputs

There are two matrix sub-mix sections in ZED-4. The send controls (black & red knobs) take the post-fade signals from the Group, Left, Right and Mono mix paths and send them to the Matrix output. Matrix outputs 1 & 2 are individual mono outputs. There is a master level control to adjust the overall output level, and an AFL (after fade listen) switch to check the Matrix mix.

Uses for Matrix outputs include:

- Record feeds. Enabling a different mix from the main PA mix to be recorded, where more of the backline sound can be dialed in to the record mix if it is low in the main PA mix.
- Zone feeds. For creating individual outputs for different areas to the main PA arena.
- Delay stack feeds. Enabling individual mix and level control of delayed speakers in large auditoriums.
- Broadcast feeds for live events that are “on air” or “on line!”

The Matrix and the Auxiliary outputs are impedance balanced as standard from the factory. There is the option to fit balanced drivers at a service centre convert the outputs to be fully electronically balanced.

## Auxiliary Output Master Level controls

The Aux master level controls adjust the overall level of each of the Aux mixes 1 to 6. The range of control is from off (fully attenuated) to +10dB.

There is an AFL (after fade listen) switch on each Aux mix to check the signal after the master level control.

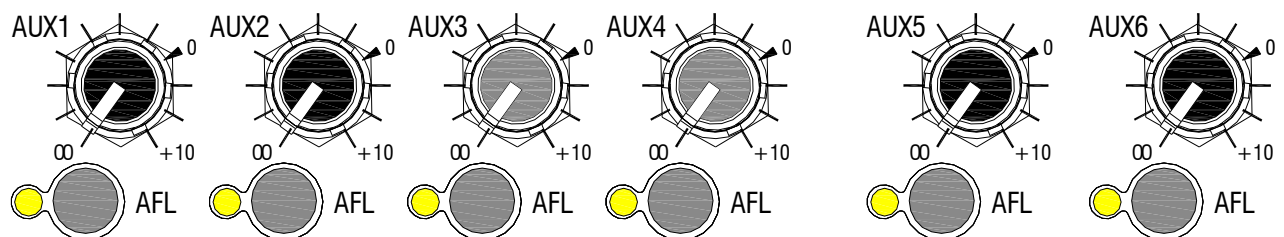

# GROUP MASTERS

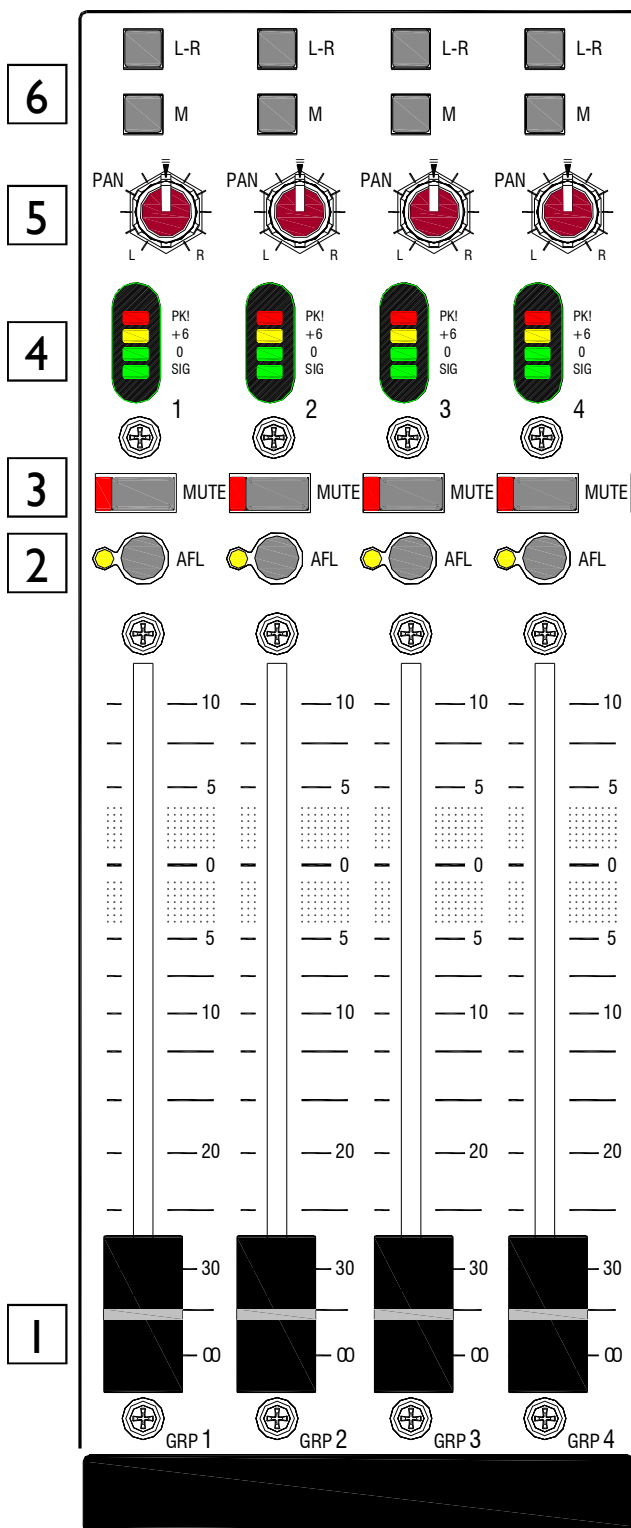

**1 Group Fader**  
The Group fader is fed with the Group mix signal via the Group Insert point. The fader has 100mm of travel and there is +10dB of gain at its maximum position.

**2 Group AFL**  
The AFL switch allows monitoring of the Group signal after the fader but before the Mute switch.

**3 Group Mute**  
The illuminated Mute switch cuts the Group signal from the Group output, sub routing and the Group meter.  
The Group signal to the Matrix outputs is also cut with the Mute switch.

**4 Group Meter**  
A 4 LED bar meter to show the level of signal on the Group output.  
The thresholds are:  
Sig = -18dB nominal, 0dB, +6dB, Pk=+16dB.  
0dB on the meter = +4dBu at the balanced output.

**5 Group Pan**  
The Pan controls how the Group signal is shared between the Left & Right main mix buses when sub-routed. The Group output is unaffected by the Pan control.

**6 Group Sub Routing**  
The L-R switch routes the panned Group signal to the main LR mix and the M switch routes the unpanned Group signal to the mono bus.  
If you want to set up a stereo pair of sub-groups and route them to the main LR mix, make sure the odd numbered Group is panned Left and the Even Group is panned Right.

# L R & M MASTERS and HEADPHONES

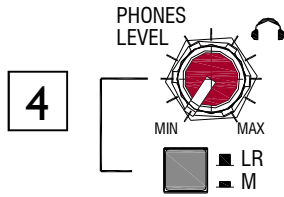

## Main Mix Fader

The L, R & M faders follow the mix insert points. The faders have 100mm of travel and 10dB of gain at the top.

1

## Main Mix Mute

Cuts the signal from the main mix output. Illuminates red when cut. Also cuts the signal from the associated Matrix feed and the headphones monitor.

2

## Main Mix Meter

A 4 LED bar meter to show the level of signal on the associated output.

The thresholds are:

Sig = -18dB nominal, 0dB, +6dB, Pk=+16dB.

0dB on the meter = +4dBu at the balanced output.

3

## Headphones Source & Level

The LR/M switch selects the signal source for the headphones, out for Left & Right, in for Mono. If any AFL or PFL switch is pressed then this will override the source selection.

The level control adjusts the volume of the headphone signal.

4



**Warning !** To avoid damage to your hearing do not operate the headphones or sound system at excessively high volume. Continued exposure to high volume sound can cause frequency selective or wide range hearing loss.

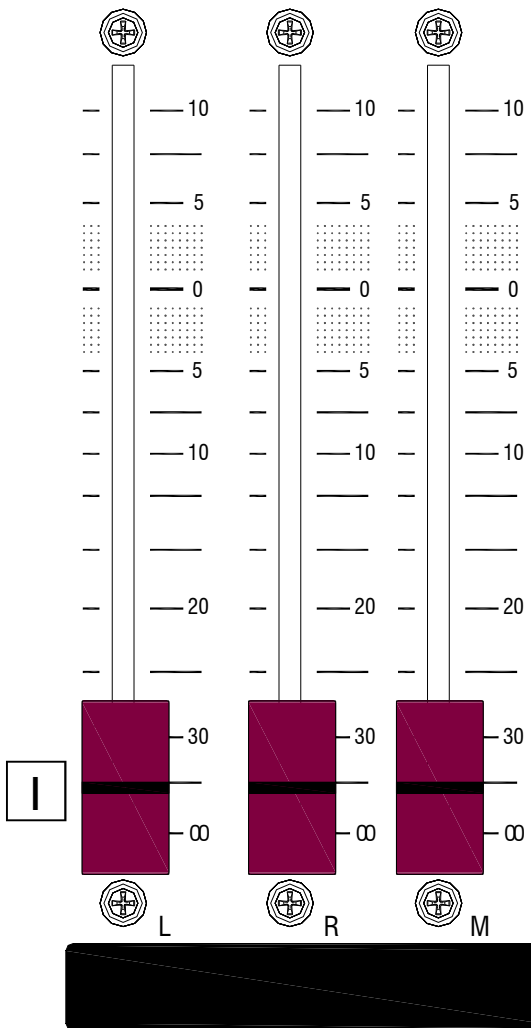
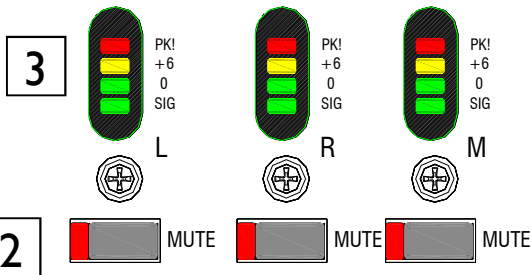



# MAIN METERS & TALKBACK

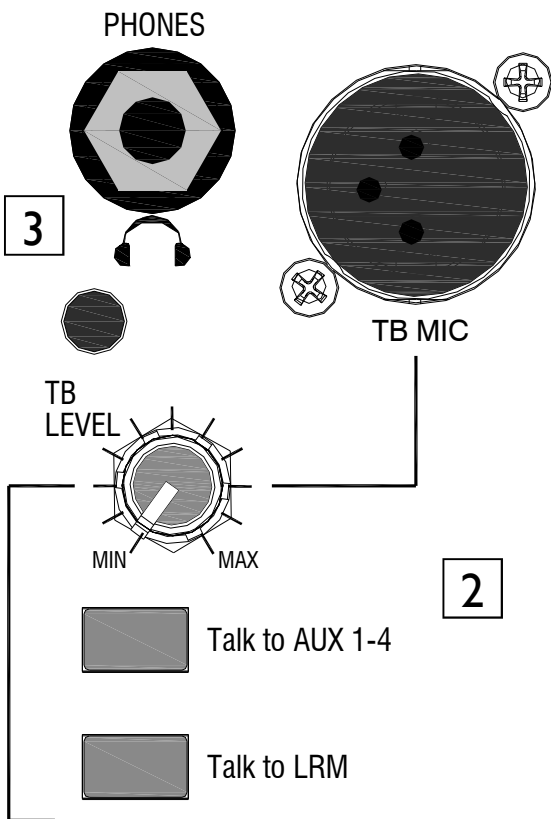

## Main Meters

1

The main Left & Right meters will show the signal level at the main LR mix outputs or the main M mix output depending on the selector switch below the Phones Level control. If any PFL or AFL switch is pressed the meters will show that signal level. Basically, the meters show the headphones monitor signal pre the headphones level control.

The PFL/AFL active LED illuminates if any PFL or AFL switch is pressed.

Note that PFL and AFL monitoring will be in mono.

## Talkback

2

A microphone xlr connector is provided with phantom power applied as a factory default.

The TB Level control varies the gain of the talkback amplifier from 20dB (MIN) to 55dB (MAX).

The two switches send the talkback signal to Auxes 1 to 4 and to the main L, R & M mixes. When not using talkback, it is best to leave these switches in their out position.

POWER

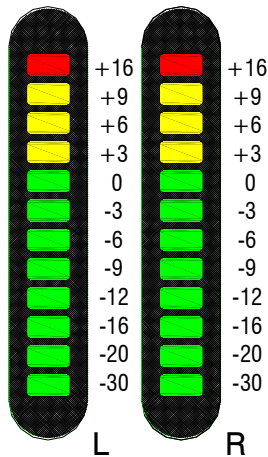

3

## Headphone Jack Sockets

Standard 1/4 inch and 3.5mm TRS jack sockets for stereo headphones. Tip = Left.

PFL/AFL ACTIVE

# USB SECTION & PLAYBACK

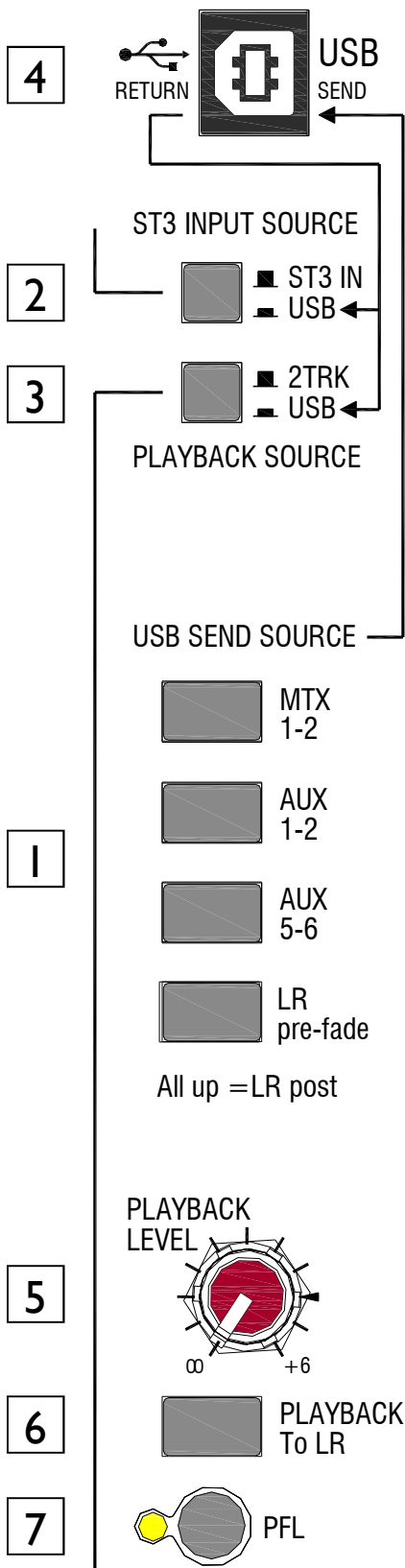

- 1 USB Send Source Selection**  
 The USB source selection switches determine which signals are sent out on the USB interface. If all the switches are up the main LR mix post-fade signal is sent. Other sources available are the pre-fade main LR mix, Auxes 5&6, Auxes 1&2 and Matrix 1&2.  
 The switches work on a priority system with the upper switch taking priority—so if all the switches are pressed in for example, the Matrix 1&2 would be selected as the source.
- 2 ST3 Input Source Selector**  
 This switch determines the signal source for the ST3 input. In the out position the source is the ST3 phono connectors, the in position is the stereo USB return.
- 2 Playback Input Source Selector**  
 This switch determines the signal source for the Playback input. In the out position the source is the 2TRK IN phono connectors, the in position is the stereo USB return.
- 4 USB Connector**  
 Standard B type USB connector.
- 5 Playback Input Level**  
 Controls the level of the playback signal from off (fully attenuated) to +6dB.
- 6 Playback To LR**  
 Routes the Playback signal (2 TRK IN or USB return) to the main LR mix.
- 7 Playback PFL**  
 Allows monitoring of the Playback signal (pre-Level) in headphones and on the main LR meters. Note the monitoring will be in mono.

# USB CONNECTION

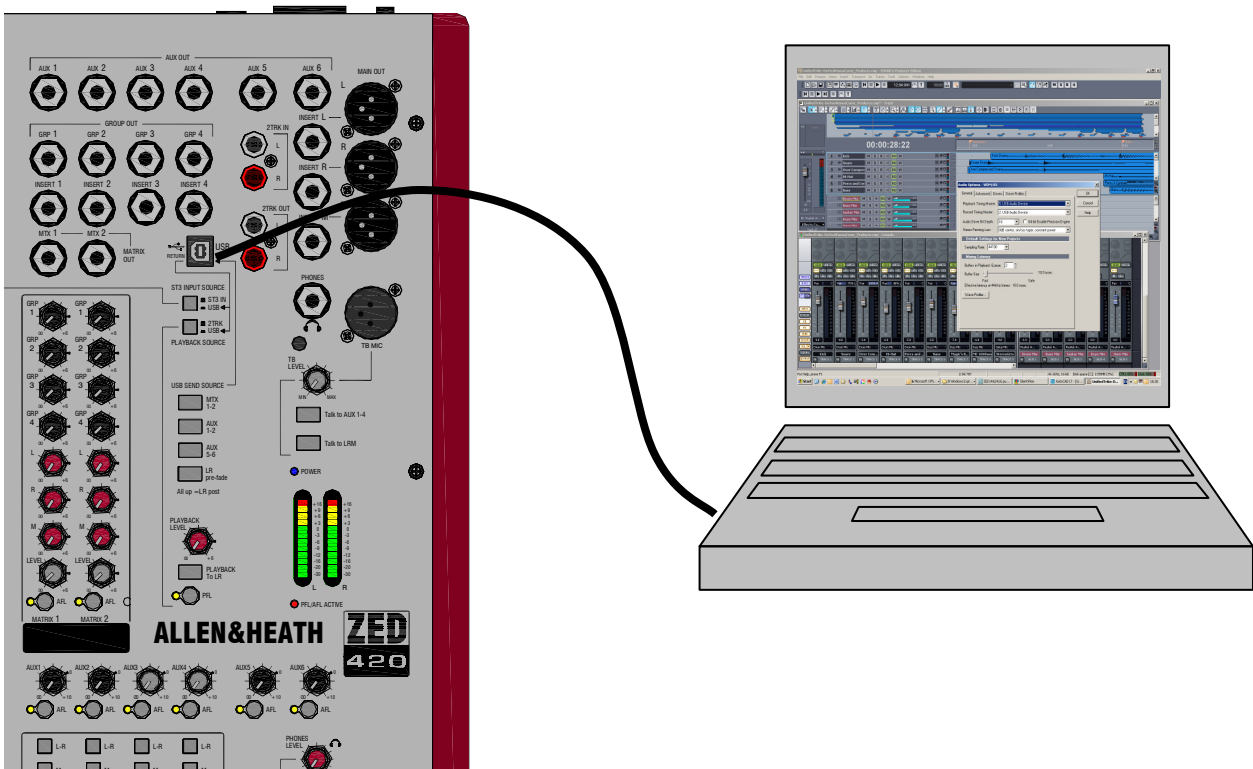

## USB Audio Interface

The ZED is equipped with a stereo bi-directional USB I.1 compliant audio CODEC. It is fully compliant with USB 2 ports and uses standard Windows and MAC Core Audio Drivers. In other words, plug it in and your computer will find it and be able to transfer audio to and from the ZED USB device.

You will need some form of audio software running on your computer to be able to record and play back what you record, but on a basic level, you can use your computers media player to play straight to the ZED device.

Just a couple of points to look out for:

1. When you plug in your ZED USB interface to your computer, check the device volume in:

### Control Panel\Sounds & Audio Devices\Volume

If the volume is not fully up like this.....

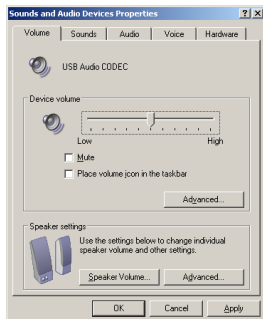

Then drag it fully up like this.....

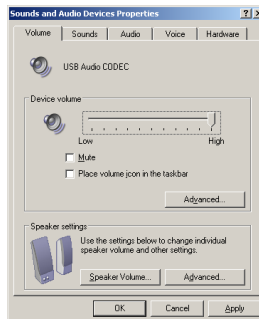

Then click **Apply**

2. If you want to reduce latency (delay) there are some different drivers available for your operating system. Please check the Allen & Heath website [www.allen-heath.com](http://www.allen-heath.com) for details and links to third party companies able to supply appropriate drivers for your operating system.



## **cakewalk SONAR LE**

DIGITAL AUDIO WORKSTATION

### **SONAR LE Overview.**

SONAR LE is a software application from Cakewalk and is included free of charge with your new ZED mixing console.

SONAR LE is a powerful first step into the world of sequencing and hard disk recording on the Windows platform. You'll be able to record from your ZED mixer, create tracks and arrange songs, then play back to your ZED mixer via the USB port. You can decide whether the SONAR family of products is right for you. If you choose to upgrade your copy of SONAR LE to a more full-featured version, like SONAR Producer or Home Studio Editions, you'll now be able to do so at significant savings.

We will describe the basic steps of installing the software and getting started here, for more comprehensive help or technical support please use the Help files in SONAR LE or visit the SONAR LE website:

<http://www.cakewalk.com/owners/sonarle/>

The website will have details on registering your product and upgrading it should you wish. There are also tutorials to get you started.

SONAR LE is the most complete OEM production software solution available today. Unlike other OEM applications, SONAR LE has been designed to provide a simple yet complete solution for creating music. You won't feel the need to upgrade just to get started.

With support for up to 64 tracks and 24 track effects, 8 physical in/outs at 24bit/192kHz, SONAR LE is able to offer a powerful pc based recording studio. The package also includes 2 instruments, 6 MIDI effects, and 14 audio effects.

SONAR LE has been updated with new features from its acclaimed SONAR Producer, making SONAR LE the first native Windows DAW for Windows XP, Windows x64, and Windows Vista.

Today's Cakewalk SONAR LE is the definitive choice for creating the most complete hardware and software solution.

### **SONAR LE Key Features.**

64 audio tracks

256 MIDI tracks

8 simultaneous inputs and outputs

24-bit/192 kHz audio quality

24 simultaneous effects

8 simultaneous virtual instruments

Integrated VST/VSTi support, without need for VST adapter

Support for ACID™-format loops

Support for ReWire clients such as Project5, Live, or Reason

Elegant user interface—NEW

Active Controller Technology™ automatically maps MIDI keyboards and control surfaces to the parameters you need most on effects, instruments, volume, pan, and other mix elements—NEW

Easier integration of virtual instruments with Synth Rack—NEW

Support for Windows Vista (32-bit & 64-bit) —NEW , Windows XP Professional x64 Edition—NEW, and Windows XP operating systems

## System Requirements.

System Requirements	Minimum	Recommended
<b>Operating System</b>	Windows XP	Windows XP/Vista/Vista x64
<b>Processor Speed</b>	Intel® Pentium® 4 1.3 GHz, or AMD™ Athlon XP 1500+ or higher	Intel® Pentium® 4 2.8 GHz [EM64T], or AMD™ Athlon 64 2800+ or higher
<b>RAM</b>	256 MB	1 GB or higher
<b>Graphics (resolution, color depth)</b>	1024 x 768, 16-bit color	1280 x 960, 32-bit color
<b>Hard Disk Space</b>	100 MB for core program	2 GB for program and content
<b>Hard Disk Type</b>	Any	EIDE/Ultra DMA (7200 RPM) or SATA
<b>MIDI Interface</b>	Windows-compatible	Windows-compatible
<b>Audio Interface</b>	Windows-compatible	WDM- or ASIO-compatible, including WaveRT for Vista
<b>Optical Drive</b>	DVD-ROM, DVD+/-R, or DVD+/-RW for installation, CD-R or CD-RW capability required for CD audio disc burning	

## SONAR LE Installation.

Put disk into CD or DVD ROM drive and follow instructions on screen!

## SONAR LE Audio Configuration with ZED.

To configure your SONAR LE software to communicate audio to and from your ZED mixing console, follow the sequence below.

Ensure the ZED mixing console is powered on.

Connect the USB lead from the computer to the USB port on ZED.

First check that your computer has recognised the connection of the ZED USB device by clicking Settings/Control Panel/Sounds and Audio Devices.

The device name should be USB Audio CODEC (ensure there are no other external audio devices attached to the computer). Also ensure the Device Volume is set to High. This can default to the middle during connection which means very low volume from the USB device, so it's worth checking the first few times you connect.

The properties window should look like this:

It is also a good idea to select "No Sounds" in the Sounds window.

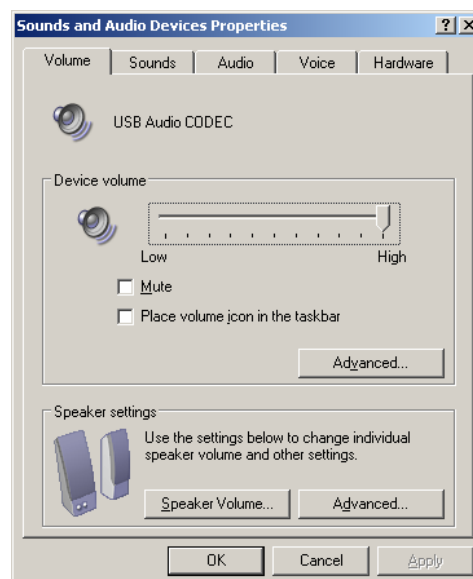

Next, fire up SONAR LE.

Click Options/Audio and click on the Drivers tab.

The Input drivers are the audio sources to the computer, here we have enabled the USB Audio Device which is the ZED mixing console USB device, and disabled the audio from the soundcard in the pc. So the computer is set up to receive audio from ZED.

The Output Drivers are the audio outputs from the computer. Here you can see that the pc soundcard has 4 stereo outputs (all disabled) and the software has located the USB Audio Device which is ZED. Tick to enable it.

You will now be able to select your ZED USB left & right outputs as inputs to SONAR LE and be able to send audio to your ZED from SONAR outputs.

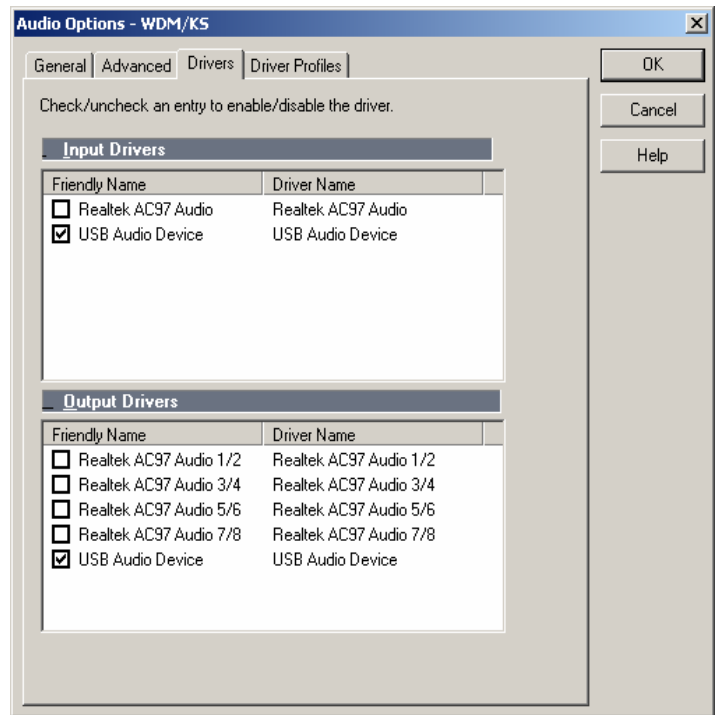

In order to show how to select inputs to SONAR tracks, here is a basic Cakewalk project (.cwp). This is created by clicking File/New/Normal and then inserting a second audio track by clicking Insert/Audio Track from the main toolbar.

Click on the I/O tab near the bottom of the window, then click the expand buttons in the audio track panes. The tracks 1 & 2 have been re-named ZED Left and ZED Right by double clicking the name field. Click the I and the O fields to select inputs and outputs for the track. Here we have selected the USB Left signal to go to Track 1 (ZED Left) and the USB Right signal to go to track 2 (ZED Right), panned them accordingly and selected the track outputs to be the Master Bus.

If audio is present, click the Input Echo buttons (lit up yellow here) to monitor the signals on the Master Bus.

The output for the Master Bus is displayed in the field marked "O" in the Master Bus pane below the input tracks. You can see here it says USB Audio Device, which is the ZED USB input. SONAR will configure this automatically if there is only one output device enabled in the Output Drivers Options window (above).

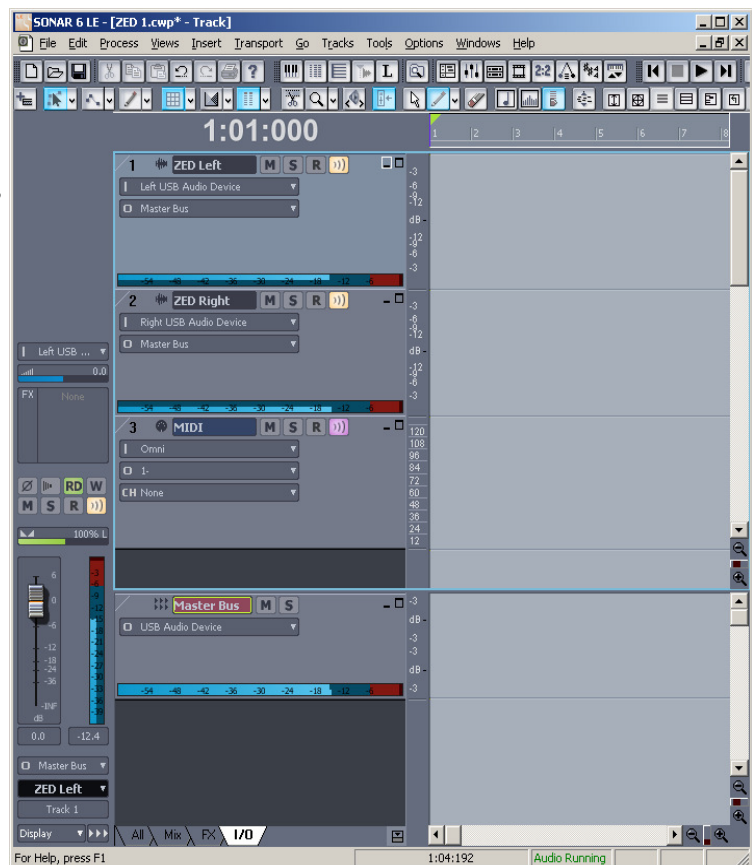

You should now be able to send audio to and from your ZED mixing console using SONAR LE.

To test this, let's do a recording...

To record the audio on tracks 1 & 2, click the R buttons so they light up red, then the record button (circle) on the transport controls on the top icon toolbar. (Or select larger transport controls from Views). The audio wave profile will show in the track panes. Click stop (Square) when finished.

To listen to the recording, click rewind, then de-select the input echo buttons (to the right of the R buttons). Also disarm the tracks by de-selecting the R buttons.

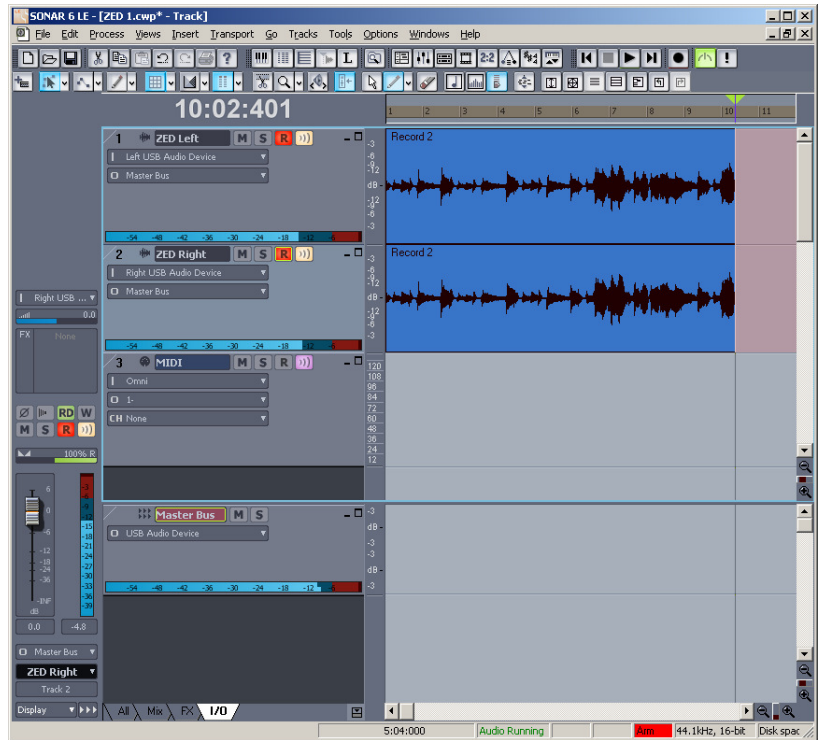

Click Play (or spacebar) and the recorded audio should play to the USB port on your ZED mixing console where you can select USB return to Playback or to the ST3 input.

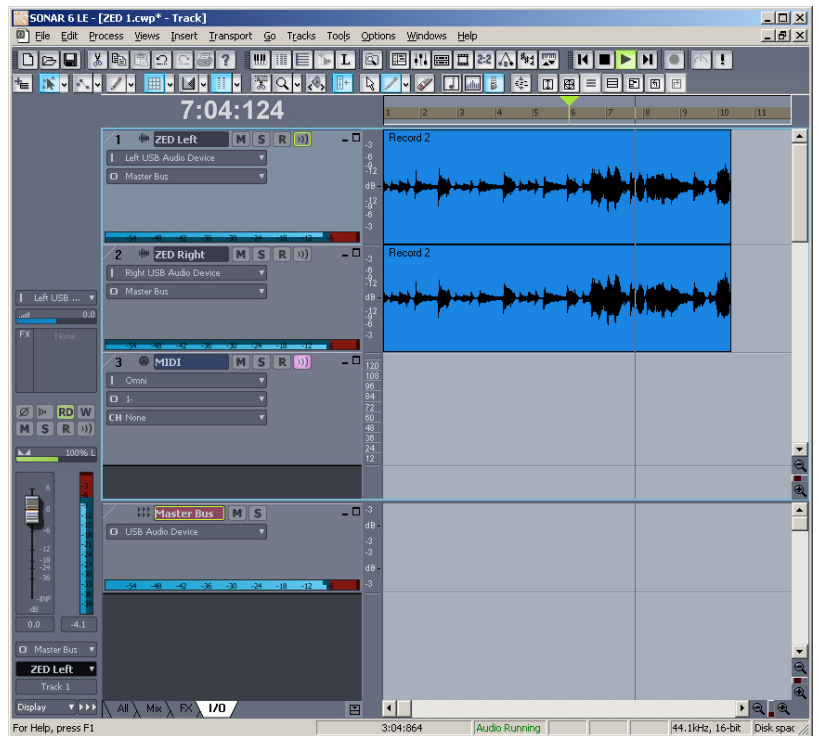

You can use SONAR LE and your ZED mixer together in many ways, for example straightforward recording of a stereo mix, recording tracks individually to build up a song, or sending a postfade mix from ZED and inserting an effects plug-in from SONAR LE, returning the post-effects signal to the mix in ZED.

It is a very versatile combination and we hope you find it a creative and enjoyable product partnership.

# USING USB FOR EFFECTS

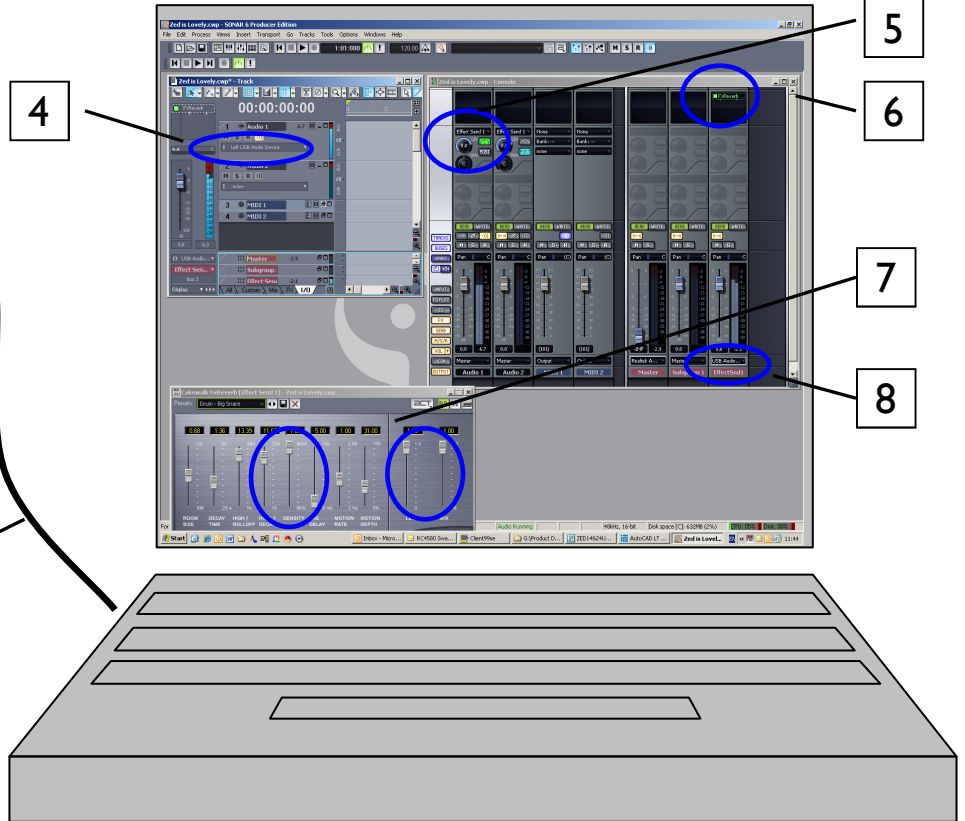
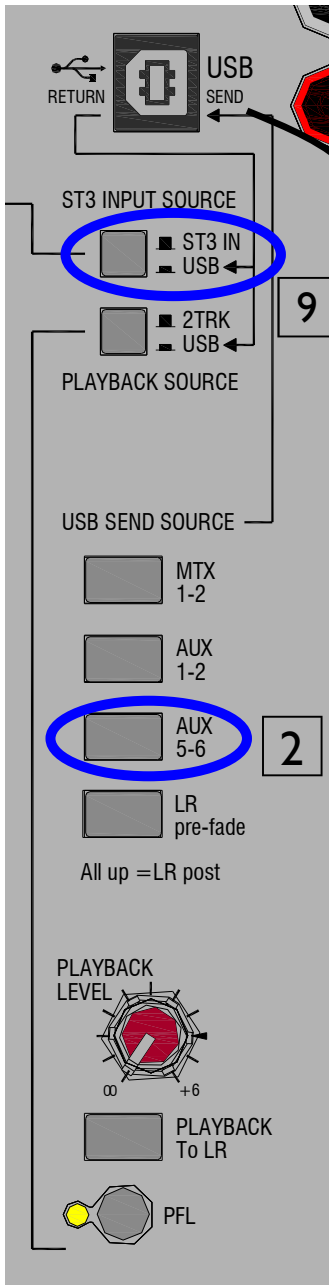

- 1 Use post fade Aux 5 & 6 as the sends from ZED so when you move the channel fader the effects level stays in proportion.
- 2 Select Aux 5-6 on the USB output selector switches.
- 3 USB lead carries the digital signals to & from the computer.
- 4 Select USB Device Left for Aux 3 or Right for Aux 4 as the input for the track in the software package.
- 5 You can use a send bus in software as you would a hardware mixer.
- 6 Assign an effect from your software plug-in list.
- 7 If using reverb, it's a good idea to have 100% wet mix level and reduce the pre-delay in order to compensate for any latency in USB.
- 8 Send the output of the software group or bus to USB Device. In this case, and probably with most reverbs, it will be stereo so it will go to left & right.
- 9 Set the USB return to be sent to ST3. It can then be sent directly to LR or to the stereo channel by pressing in the under-panel switch below the ST3 Level control.

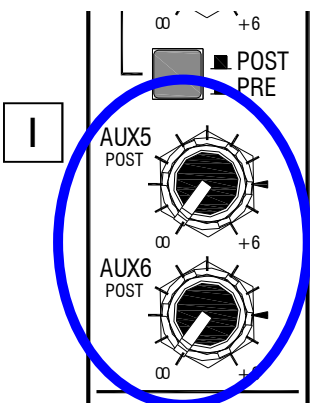



# WIRING NOTES

## Insert cable wiring

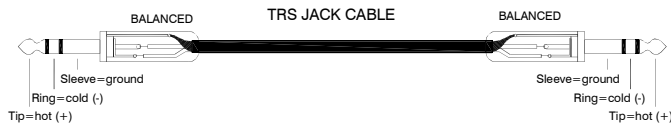
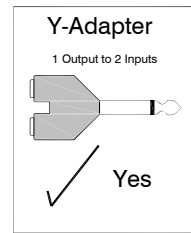
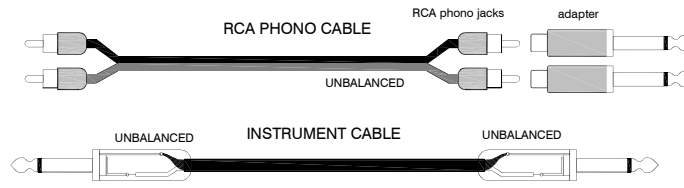
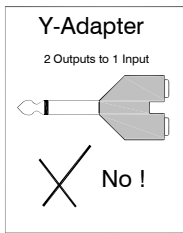
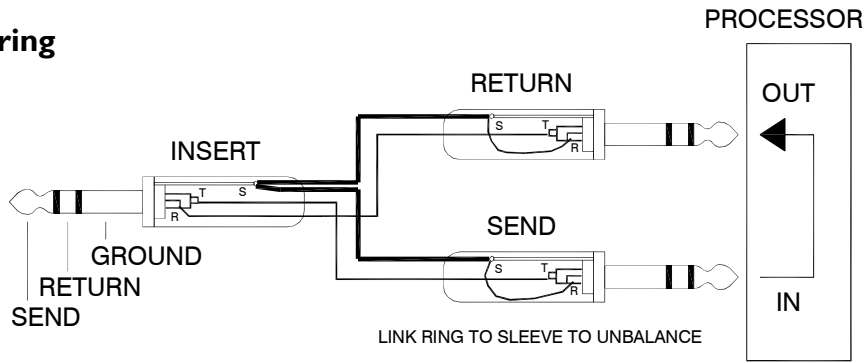

TO INPUT

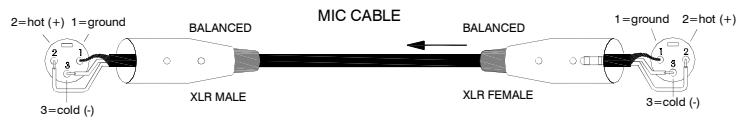

FROM OUTPUT

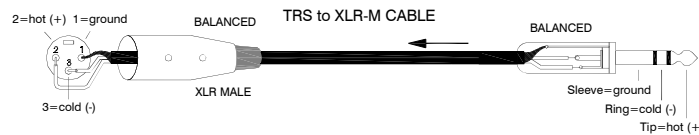
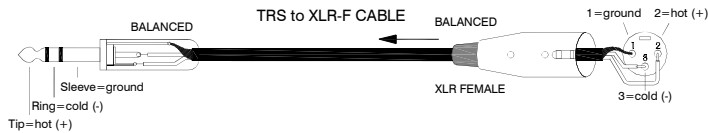

## General Wiring Information

# PRODUCT SUPPORT

Investigate ALLEN & HEATH's other ranges at [www.allen-heath.com](http://www.allen-heath.com)

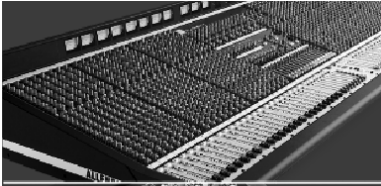

Large Live Sound mixers — iLive digital, ML and GL Series

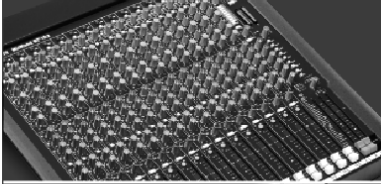

Small Format Live Sound mixers — ZED, MixWizards and PA Series



DJ products — Xone Series



Sound Management Series — iDR Series

## Registering your product

Thank you for buying the Allen & Heath ZED-4 mixer. We hope that you are happy with it and that you enjoy many years of faithful service with it.

Please go to [www.allen-heath.com/register.asp](http://www.allen-heath.com/register.asp) and register your product's serial number and your details. By registering with us and becoming an official Registered User, you will ensure that any warranty claim you might make is actioned quickly and with the minimum delay.

Alternatively, you may either copy or cut off this section of the page, fill in the details, and return it by mail to: Allen & Heath Ltd, Kernick Industrial Estate, Penryn, Cornwall TR10 9LU, UK



### ALLEN&HEATH PRODUCT REGISTRATION

Thank you for buying an Allen & Heath product. We hope that you're happy with it and that you enjoy many years of faithful service with it.

SERIAL NUMBER
---------------

Please return this section of the card by mail and retain the other part for your records. You can also register online at [www.allen-heath.com](http://www.allen-heath.com). Thanks for your help.

Your Name: \_\_\_\_\_

Company Name: \_\_\_\_\_

Address 1: \_\_\_\_\_

Address 2: \_\_\_\_\_

Town/City: \_\_\_\_\_ County/State: \_\_\_\_\_

Country: \_\_\_\_\_ Postcode/Zip: \_\_\_\_\_

Telephone: \_\_\_\_\_

Email: \_\_\_\_\_

Why did you choose this console? \_\_\_\_\_

Which other products did you consider before choosing A&H? \_\_\_\_\_

Is there any thing you would like to improve on this mixer? \_\_\_\_\_

What audio magazines do you read? \_\_\_\_\_

If you were going to design a mixer for your work, what are the 6 most important features it should have (in order of importance)

1	2
3	4
5	6

We may use the information you provide to inform you of future product developments. We will not give or sell this data to third parties. Please indicate with an 'x' if you do not wish to receive any further communications from us.



